

An introduction to **circlize** package

Zuguang Gu <z.gu@dkfz.de>

March 7, 2017

Circular layout is very useful to represent complicated information, especially for genomic data. It has advantages to visualize data with long axes or large amount of categories, described with different measurements. It is also effective to visualize relations between elements.

Circos (<http://circos.ca>) is an extraordinarily cool tool to make such circular layout and it is broadly used in real applications, not just popular in Genomic but in a lot of other areas as well. It is not only a way to visualize data, but also enhances the representation of scientific results into a level of aesthetics. Therefore, most people call figures with circular layout as ‘circos plot’. Here the **circlize** package¹ aims to implement **Circos** in R. One important advantage for the implementation in R is that R is an ideal environment which provides seamless connection between data analysis and data visualization. This package is not a front-end wrapper to generate configuration files for **Circos**, but completely coded in R style by using R’s elegant statistical and graphic engine. We aim to keep the flexibility and configurability of **Circos**, also make the package more straightforward to use and enhance it to support more types of graphics.

1 Principle of design

Since most of the figures are composed of simple graphics, such as points, lines, polygon (for filled colors) *et al*, **circlize** implements low-level graphic functions for adding graphics in circular layout, so that more higher level graphics can be easily comprised by low-level graphics. This principle ensures the generality that types of high-level graphics are not restricted by the software but determined by users.

Currently there are following graphic functions that can be used for plotting, they are similar to the functions without “*circos.*” prefix from the traditional graphic engine (you can also see the correspondence in figure 1):

- `circos.points`: add points in a cell, similar as `points`.
- `circos.lines`: add lines in a cell, similar as `lines`.
- `circos.rect`: add rectangle in a cell, similar as `rect`.
- `circos.polygon`: add polygon in a cell, similar as `polygon`.
- `circos.text`: add text in a cell, similar as `text`.
- `circos.axis`: add axis in a cell, functionally similar as `axis` but with more features.
- `circos.link`: this maybe the unique feature for circular layout to represent relationships between elements.

For adding points, lines and text in cells through the whole track (among several sectors), the following functions are available:

- `circos.trackPoints`: this can be replaced by `circos.points` through a for loop.
- `circos.trackLines`: this can be replaced by `circos.lines` through a for loop.

¹It would be great if you can cite: Gu Z *et. al.* (2014) *circlize* implements and enhances circular visualization in R. *Bioinformatics*.

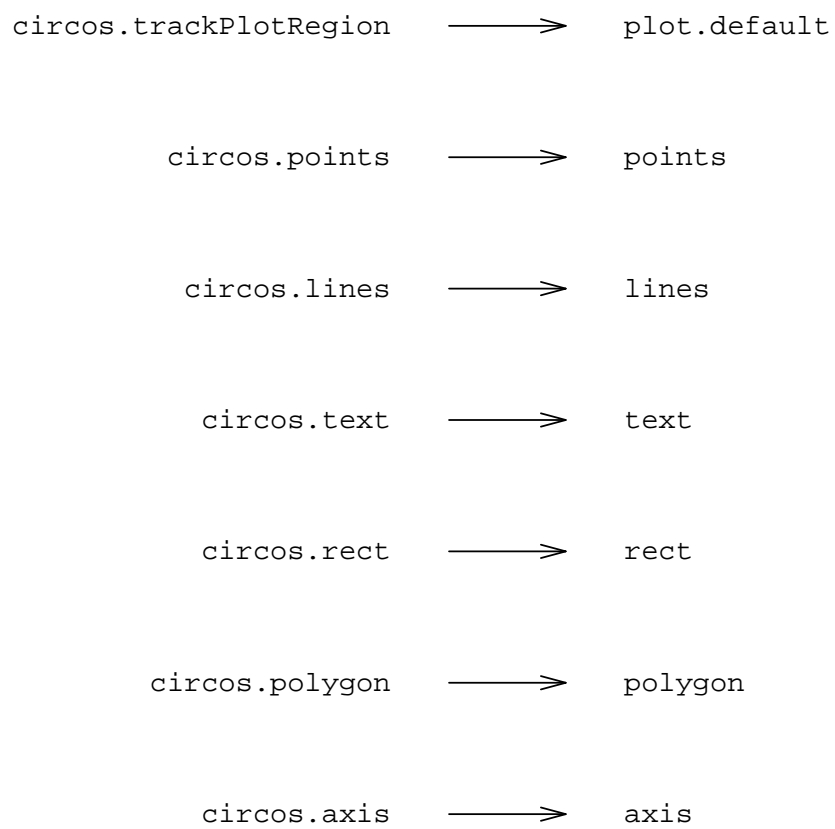

Figure 1: Correspondence between graphic functions in **circize** and in traditional R graphic engine.

- `circos.trackText`: this can be replaced by `circos.text` through a for loop.

Functions to arrange the circular layout:

- `circos.trackPlotRegion`: create plotting regions for cells in a track.
- `circos.updatePlotRegion`: update an existed cell.
- `circos.par`: graphic parameters.
- `circos.info`: print general parameters of current `circos` plot.
- `circos.clear`: reset graphic parameters and internal variables.

Theoretically, you are able to draw most kinds of `circos` figures by the above functions. As you will see, all the figures which are ‘round’ in the six vignettes are all generated by **circlize** package.

The following part of this vignette is structured as follows: First there is an example to give a quick glance of how to implement a circular layout by **circlize**. Then we introduce the basic principle (or the order of using the `circos` functions) for plotting. After that there are detailed explanations of graphic parameters, coordinates transformation and usage of low-level functions. Finally we introduce some tricks for making more complicated `circos` plots.

2 A quick glance

Following is an example to show the basic feature and usage of **circlize** package. First let’s generate some random data. There needs a factor to represent categories, values on x-axis, and values on y-axis.

```
set.seed(999)
n = 1000
a = data.frame(factor = sample(letters[1:8], n, replace = TRUE),
  x = rnorm(n), y = runif(n))
```

First initialize the layout. In this step, `circos.initialize` allocates sectors in the circle according to ranges of x-values in different categories. E.g, if there are two categories, range for x-values in the first category is `c(0, 2)` and range for x-values in the second category is `c(0, 1)`, the first category would hold approximately 67% areas of the circle. Here we only need x-values because all cells in a sector share the same x-ranges.

We explicitly set `par(mar)` because the default graphic device has equal values of width and height, we set the figure margins to a same value to make sure the plot that we make is a real circle.

```
library(circlize)
par(mar = c(1, 1, 1, 1), lwd = 0.1, cex = 0.7)
circos.par("track.height" = 0.1)
circos.initialize(factors = a$factor, x = a$x)
```

Draw the first track (figure 2 A). Before drawing any track we need to know that all tracks should firstly be created by `circos.trackPlotRegion`, then those low-level functions can be applied (recall in traditional R graphic engine, you need first call `plot.default` and then you can use functions such as `points` and `lines` to add graphics on it). Since x-lims for cells in the track have already been defined in the initialization step, here we only need to specify the y-lim for each cell, either by `y` or `ylim` argument.

We also add axes in the first track, The axis for each cell is added by `panel.fun` argument. `circos.trackPlotRegion` creates plotting region cell by cell and the `panel.fun` is actually executed immediately after the creation of the plotting region for a certain cell. So `panel.fun` actually means adding graphics in the “current cell”. After that, we add points through the whole track by `circos.trackPoints`. Finally, add two texts in a certain cell (the cell is specified by `sector.index` and `track.index` argument). When adding the second text, we do not specify `track.index` because the package knows we are now in the first track.

Here what should be noted is that the first track has a index number of 1. An internal variable which traces the tracks would set the ‘current track index’ to 1. So if the track index is not specified

in the plotting functions such as `circos.trackPoints` and `circos.text` which are called after the creation of the track, the current track index would be used as the default track index. (Details will be explained in the following sections).

```
circos.trackPlotRegion(factors = a$factor, y = a$y,
  panel.fun = function(x, y) {
    circos.axis()
  })
col = rep(c("#FF0000", "#00FF00"), 4)
circos.trackPoints(a$factor, a$x, a$y, col = col, pch = 16, cex = 0.5)
circos.text(-1, 0.5, "left", sector.index = "a", track.index = 1)
circos.text(1, 0.5, "right", sector.index = "a")
```

Draw the second track (figure 2 B). We use `circos.trackHist` to add histograms in the track. The function also creates a new track because drawing histogram is really high level, so we do not need to call `circos.trackPlotRegion` here. The index for this track is 2.

```
bgcol = rep(c("#EFEFEF", "#CCCCCC"), 4)
circos.trackHist(a$factor, a$x, bg.col = bgcol, col = NA)
```

Draw the third track (figure 2 C). Here some meta data for the current cell can be obtained by `get.cell.meta.data`. This function needs `sector.index` and `track.index` arguments, and if they are not specified, it means it is the current sector index and the current track index.

```
circos.trackPlotRegion(factors = a$factor, x = a$x, y = a$y,
  panel.fun = function(x, y) {
    grey = c("#FFFFFF", "#CCCCCC", "#999999")
    sector.index = get.cell.meta.data("sector.index")
    xlim = get.cell.meta.data("xlim")
    ylim = get.cell.meta.data("ylim")
    circos.text(mean(xlim), mean(ylim), sector.index)
    circos.points(x[1:10], y[1:10], col = "red", pch = 16, cex = 0.6)
    circos.points(x[11:20], y[11:20], col = "blue", cex = 0.6)
  })
```

You can update an existed cell by specifying `sector.index` and `track.index` in `circos.updatePlotRegion`. The function erases graphics which have been added. Here we erase graphics in one cell in track 2, sector d and re-add some points (figure 2 D). `circos.updatePlotRegion` can not modify the `xlim` and `ylim` of the cell as well as other settings related to the position of the cell. `circos.updatePlotRegion` will modify current sector index and track index.

```
circos.updatePlotRegion(sector.index = "d", track.index = 2)
circos.points(x = -2:2, y = rep(0, 5))
xlim = get.cell.meta.data("xlim")
ylim = get.cell.meta.data("ylim")
circos.text(mean(xlim), mean(ylim), "updated")
```

Draw the fourth track (figure 2 E). Here you can choose different line types which is similar as `type` argument in `lines`.

```
circos.trackPlotRegion(factors = a$factor, y = a$y)
circos.trackLines(a$factor[1:100], a$x[1:100], a$y[1:100], type = "h")
```

Draw links (figure 2 F). Links can be from point to point, point to interval or interval to interval. Some of the arguments will be explained in the following sections.

```
circos.link("a", 0, "b", 0, h = 0.4)
circos.link("c", c(-0.5, 0.5), "d", c(-0.5, 0.5), col = "red",
  border = "blue", h = 0.2)
circos.link("e", 0, "g", c(-1, 1), col = "green", border = "black", lwd = 2, lty = 2)
```

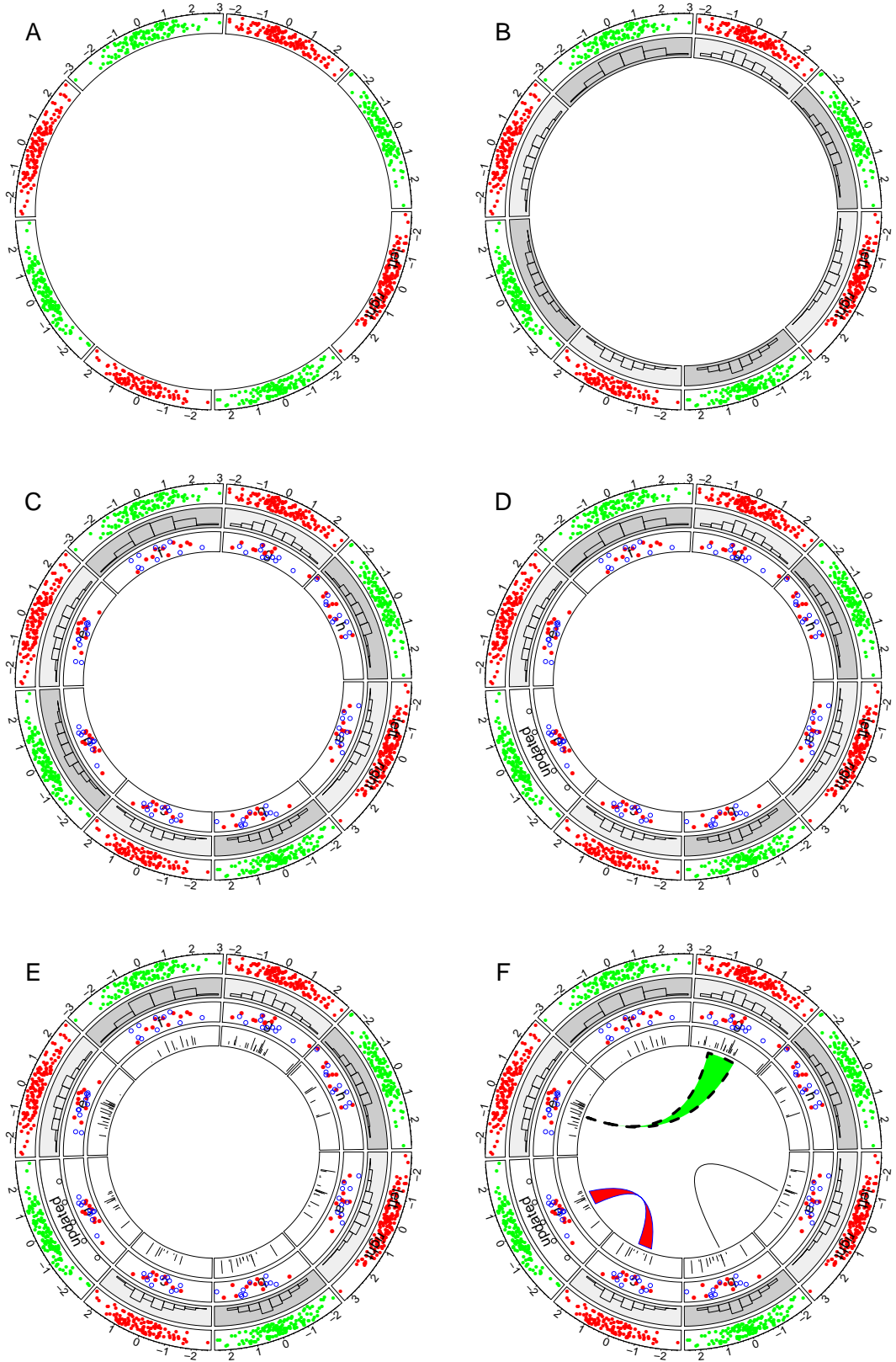

Figure 2: A step-by-step example by *circlize*.

You can get a summary of your circular layout by `circos.info`.

```
circos.info()
circos.info(sector.index = "a", track.index = 2)
```

Finally we need to reset the graphic parameters and internal variables, so that it will not mess up your next plot.

```
circos.clear()
```

3 Details

In this section, more details of the package are explained.

3.1 Coordinate transformation

There is a **data coordinate** in which the range for x-axis and y-axis is the range of data, a **polar coordinate** to allocates graphics on the circle and a **canvas coordinate** which really draws the graphics to the device (figure 3). Since a circos plot is composed by cells which are intersection of sectors and tracks, each cell has its own data coordinate. The package first transforms from the data coordinate to a polar coordinate and finally transforms into the canvas coordinate.

The final canvas coordinate is in fact an ordinary coordinate in R plotting system with x-range from -1 to 1 and y-range from -1 to 1 by default.

It should be noted that the circular layout is always (or mostly except you want to draw something out of the circle) drawn inside the circle which has radius of 1 (unit circle), from outside to inside.

For users, they only need to imagine that each cell is a normal rectangular plotting region (data coordinate) in which x-lim and y-lim are ranges of data in the category respectively. `circos` knows which cell you are in and does all the transformations automatically.

3.2 Rules for making circular layout

The rules for making circular layout is rather simple. It follows the sequence of “initialize - create track - add graphics - create track - add graphics - ... - clear” (figure 4). Details are as follows:

1. Initialize the layout using `circos.initialize`. Since circular layout in fact visualizes data which is in categories, there should be a factor and a x-range variable to allocate categories into sectors.
2. Create plotting regions for the new track and add graphics. The new track is created just inside the previously created one and the index of the track is added by 1. Only after the creation of the track can you add other graphics on it. There are three ways to add graphics in cells.
 - (a) After the creation of the track, use low-level graphic function like `circos.points`, `circos.lines`, ... to add graphics cell by cell. It always involves a for loop.
 - (b) Use `circos.trackPoints`, `circos.trackLines`, ... to add graphics through all cells simultaneously. However, it is not recommended because it would make you a little confused and also it cannot make complicated graphics.
 - (c) Use `panel.fun` argument in `circos.trackPlotRegion` to add graphics immediately after the creation of a certain cell. `panel.fun` needs two arguments `x` and `y` which are x-values and y-values that are in the current category. This subset operation is applied automatically. This is the most recommended way.

Plotting regions for cells which have already been created can be updated by `circos.updatePlotRegion`. `circos.updatePlotRegion` will erase everything that you added before.

Low level functions such as `circos.points` can be applied to any created cell by specifying `sector.index` and `track.index`.

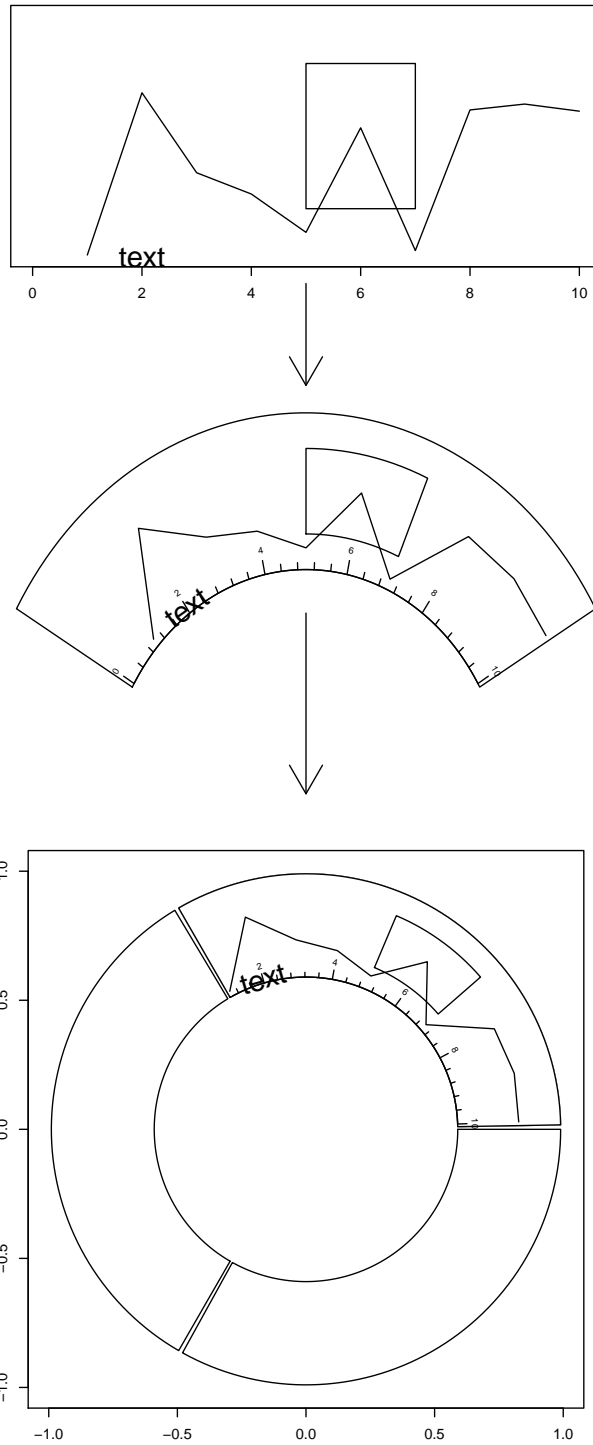

Figure 3: Transformation between different coordinates. Top: data coordinate; Middle: polar coordinate; Bottom: canvas coordinate.

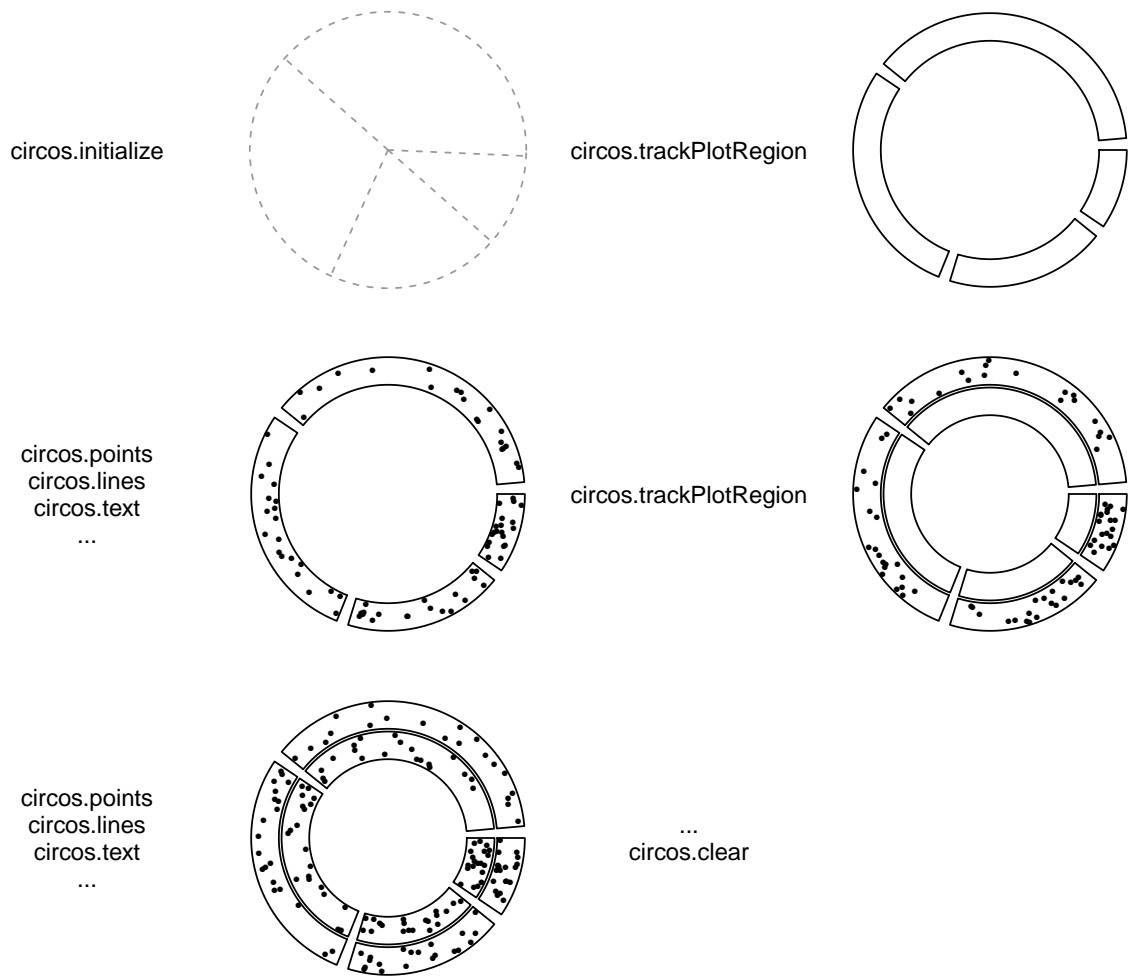

Figure 4: Order of drawing circular layout.

3. Repeat step 2 to add more tracks on the circle unless it reaches the center of the circle.
4. Call `circos.clear` to do cleaning.

As mentioned above, there are three ways to add graphics on the created track.

1. create plotting regions for the whole track and then add graphics by specifying `sector.index` and `track.index`. In the following pseudo code, `x1, y1` are data points in a given cell, which means you need to do data subsetting by yourself.

```
circos.initialize(factors, xlim)
circos.trackPlotRegion(factors, ylim)
for(sector.index in all.sector.index) {
  circos.points(x1, y1, sector.index)
  circos.lines(x2, y2, sector.index)
}
```

2. add graphics through a batch mode. This can be replaced by `circos.points` or `circos.lines` in a for loop. In the following code, you need to specifying the factors and now `x` and `y` are data points for all categories. The data points for a given cell will be subsetted according factors.

```
circos.initialize(factors, xlim)
circos.trackPlotRegion(factors, ylim)
circos.trackPoints(factors, x, y)
circos.trackLines(factors, x, y)
```

3. use a panel function to add self-defined graphics as soon as the cell has been created. This is the way recommended since when you look at `panel.fun`, it is just like adding graphics in traditional R graphics system. There will be a more detailed explanation of `panel.fun` argument in the following sections.

```
circos.initialize(factors, xlim)
circos.trackPlotRegion(factors, all_x, all_y, ylim,
  panel.fun = function(x, y) {
    circos.points(x, y)
    circos.lines(x, y)
  })
```

There is several internal variables keeping tracing of the current sector and track when applying `circos.trackPlotRegion` and `circos.updatePlotRegion`. So although functions like `circos.points`, `circos.lines` need to specify the index of sector and track, they will take the current one by default. As a result, if you draw points, lines, text *et al* just after the creation of the track or cell, you do not need to set the sector index and the track index explicitly and it will be put in the most recently created cell. Note again, only `circos.trackPlotRegion` and `circos.updatePlotRegion` can reset the current track index and sector index.

Finally, in `circlize` package, function with prefix “`circos.track`” would affect all cells in one track.

3.3 Sectors and tracks

A circular layout is composed of sectors and tracks, as illustrated in figure 5. The red circle is the track and the blue one is the sector. The intersection of a sector and a track is called a cell which can be thought as an imaginary plotting region for data points in a certain category (**data coordinate**).

Sectors are first allocated on the circle and determined by `circos.initialize`, then track allocation is determined by `circos.trackPlotRegion`. `circos.initialize` needs a category variable and data value which implicates the range of data in each category. The range of data can be specified either by `x` or `xlim`.

```
circos.initialize(factors, x)
circos.initialize(factors, xlim)
```

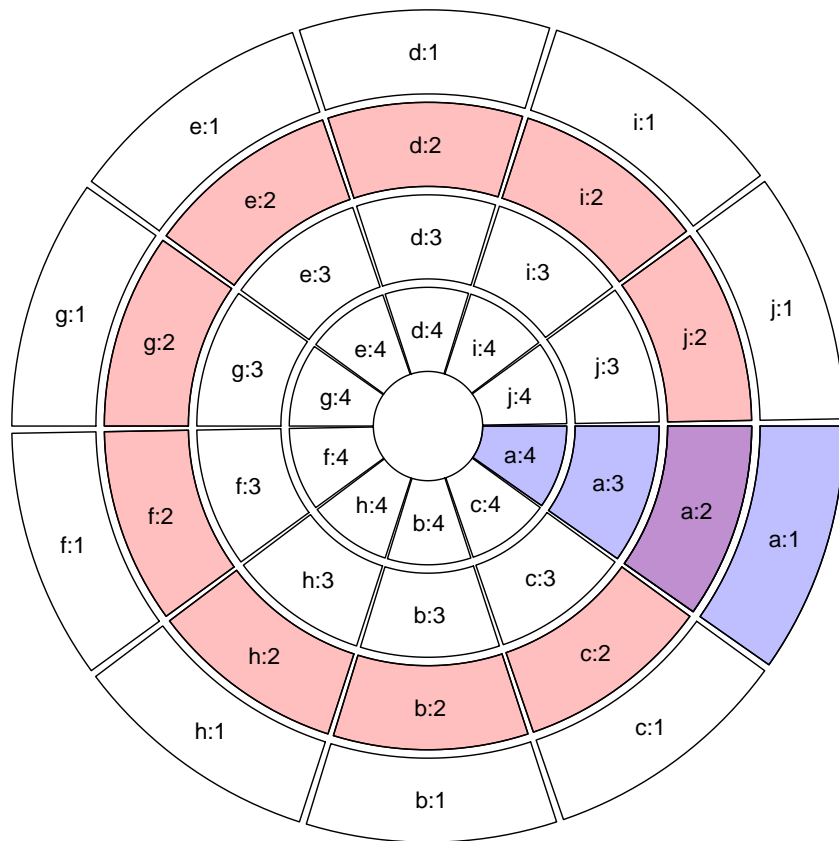

Figure 5: Sectors and tracks in circular layout. There are 10 sectors and 4 tracks. Orders of sectors are randomly permuted.

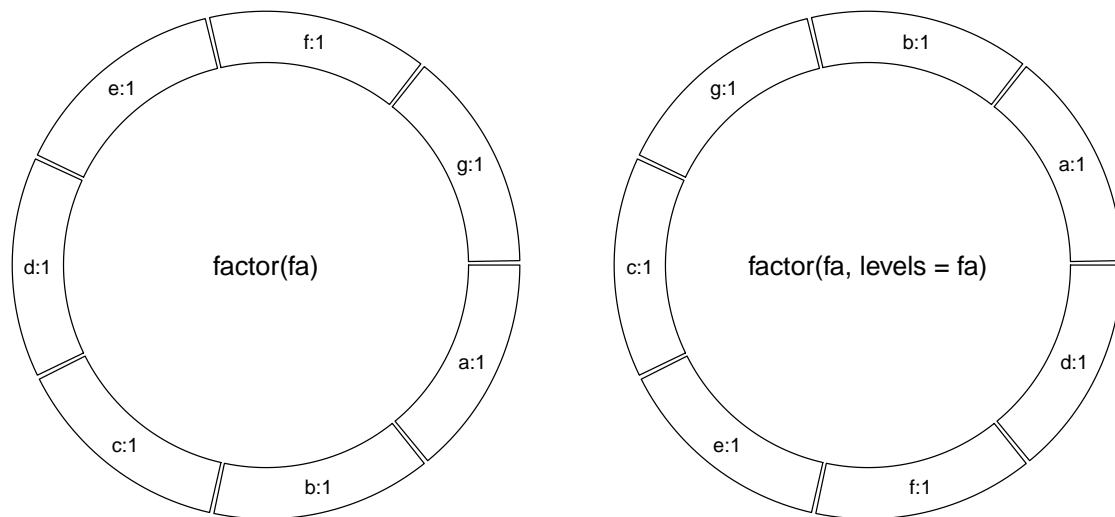

Figure 6: Different sector orders.

There are something very important that should be noted in the initialization step. In this step, not only the width of each sector is assigned, but also the order of sectors on the circle is determined. **Order of the sectors are determined by the order of levels of the factor.** So if you want to change the order of the sectors, just change of the level of factors variable. The following codes would generate different figures (figure 6):

```
fa = c("d", "f", "e", "c", "g", "b", "a")
f1 = factor(fa)
circos.initialize(factors = f1, xlim = c(0, 1))
f2 = factor(fa, levels = fa)
circos.initialize(factors = f2, xlim = c(0, 1))
```

If x which is the x -values corresponding to factors is specified, the range for x -values in different categories will be calculated according to factors automatically. And if $xlim$ is specified, it should be either a matrix which has same number of rows as the length of the factors levels or a two-element vector. If it is a two-element vector, it would be extended to a matrix which has the same number of rows as the length of factors levels. Here, every row in $xlim$ corresponds to the x -ranges of a category and the order of rows in $xlim$ corresponds to the order of levels of factors.

Since all cells in one sector and in different tracks share the same x -ranges, for each track, we only need to specify the y -ranges for cells. Similar as `circos.initialize`, `circos.trackPlotRegion` can also receive either y or $ylim$ argument to specify the range of y -values. There is also a `force.ylim` argument to specify whether all cells in one same track should share the same y -ranges. `force.ylim` is only used along with y .

```
circos.trackPlotRegion(factors, y)
circos.trackPlotRegion(factors, ylim)
```

In the track creation step, since all sectors are already allocated in the circle, if factors argument is not set, `circos.trackPlotRegion` would create plotting regions for all available sectors. Also, levels of factors do not need to be specified explicitly because the order of sectors has already be determined in the initialization step. If users only create cells for part of sectors in the track (not all sectors), in fact, cells in remaining unspecified sectors are created as well, but with no borders (pretending they are not created).

Cells are basic units in the circle and are independent with each other. After the creation of cells, they have self-contained meta values of x -lim and y -lim (data range measured in data coordinate). So if you are adding graphics in one cell, you do not need to consider things outside the cell and also you do not need to consider you are in the circle. Just pretending it is rectangle area.

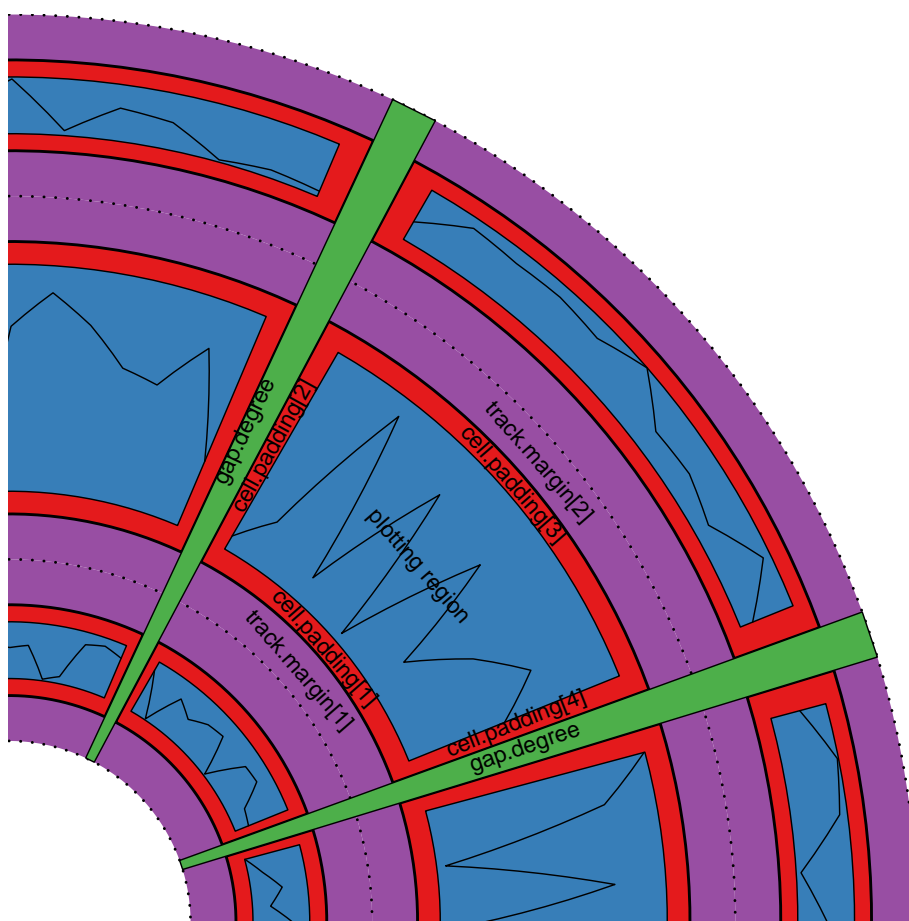

Figure 7: Regions in a cell

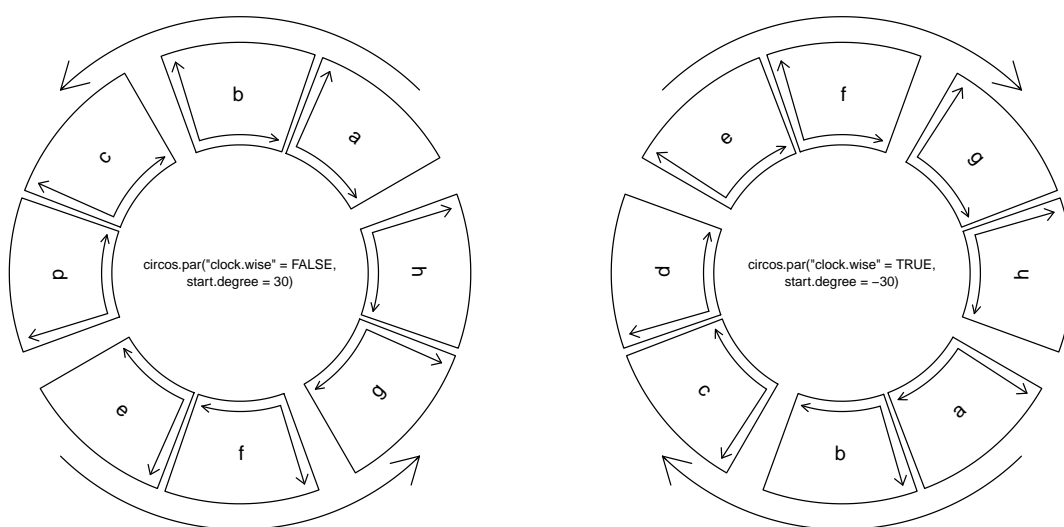

Figure 8: Sector directions. Sector orders are a, b, . . . , h.

3.4 Graphic parameters

Some basic parameters for the circular layout can be set through `circos.par`. The parameters are as follows, note some parameters can only be assigned before the initialization of the circular layout.

- `start.degree`: The starting degree where to put the first sector. Note this degree is measured in the standard polar coordinate which means it is always reverse clockwise. See figure 8.
- `gap.degree`: Gap between two neighbour sectors. It can be a single value which means all gaps share same degree, or a vector which has same length as factors levels. **The first gap is after the first sector.** See figure 8 and figure 7.
- `track.margin`: Like margin in Cascading Style Sheets (CSS), it is the blank area out of the plotting region, also outside of the borders. Since left and right margin are controlled by `gap.degree`, only bottom and top margin need to be set. The value for the `track.margin` is the percentage to the radius of the unit circle. See figure 7.
- `cell.padding`: Padding of the cell. Like padding in Cascading Style Sheets (CSS), it is the blank area around the plotting regions, but within the borders. The parameter has four values, which control the bottom, left, top and right padding respectively. The first and the third padding values are the percentages to the radius of the unit circle, and the second and fourth values are the degrees. See figure 7.
- `unit.circle.segments`: Since curves are simulated by a series of straight lines, this parameter controls the amount of segments to represent a curve. The minimal length of the line segment is the length of the unit circle (2π) divided by `unit.circle.segments`. More segments means better approximation for the curves, while generate larger file size if figures are in PDF format.
- `track.height`: The default height of tracks. It is the percentage to the radius of the unit circle. The height includes the top and bottom cell paddings but not the margins.
- `points.overflow.warning`: Since each cell is in fact not a real plotting region but only an ordinary rectangle (or more precisely, rectangle-like), it does not remove points that are plotted outside of the region. So if some points are out of the plotting region, by default, the package would continue drawing the points and print warnings. But in some circumstances, draw something out of the plotting region is useful, such as adding some legend or text. Set this value to FALSE to turn off the warnings.
- `canvas.xlim`: The coordinate for the canvas. **circize** is forced to put everything in side the unit circle, so `xlim` and `ylim` for the canvas would be `c(-1, 1)` by default. However, you can set it to a more broad interval if you want to draw other things out of the circle. By choose proper `canvas.xlim` and `canvas.ylim`, you can only draw part of the circle. E.g. setting `canvas.xlim` to `c(0, 1)` and `canvas.ylim` to `c(0, 1)` would only draw circle in the region of $(0, \pi/2)$.
- `canvas.ylim`: The coordinate for the canvas.
- `clock.wise`: The order of drawing sectors. Default is TRUE which means clockwise (figure 8). **But note that inside each cell, the direction of x-axis is always clockwise and direction of y-axis is always from inside to outside in the circle.**

Default values for graphic parameters are in table 1.

Parameters related to the allocation of sectors cannot be changed after the initialization of the circular layout. So `start.degree`, `gap.degree`, `canvas.xlim`, `canvas.ylim` and `clock.wise` can only be modified before `circos.initialize`. The second and the fourth element of `cell.padding` (left and right paddings) can not be modified either (or will be ignored).

3.5 Create plotting region

As described above, only after creating the plotting region can you add low-level graphics on it. The minimal set of arguments for this function is to set either `y` or `ylim` which assigns range of `y`-values for the track. `circos.trackPlotRegion` create tracks for all sectors although in some case only parts of them are visible.

parameter	default value
start.degree	0
gap.degree	1
track.margin	c(0.01, 0.01)
cell.padding	c(0.02, 1.00, 0.02, 1.00)
unit.circle.segments	500
track.height	0.2
points.overflow.warning	TRUE
canvas.xlim	c(-1, 1)
canvas.ylim	c(-1, 1)
clock.wise	TRUE

Table 1: Default graphic parameters

If `factors` is not specified, all cells in the track will be created with the same settings. If `factors`, `x` and `y` are set, they need to be vectors with the same length. Proper values of `x` and `y` that correspond to current cell will be passed to `panel.fun` by subsetting `factors` internally.

Graphic arguments such as `bg.border` and `bg.col` can either be a scalar or a vector. If it is a vector, the length must be equal to the length of `factors` levels and the order should also correspond to the order of `factors` levels. Thus you can create plot regions with different styles of borders and background colors.

If you are confused with the `factors` orders, you can also customize the borders and background colors inside `panel.fun`. `get.cell.meta.data("cell.xlim")` and `get.cell.meta.data("cell.ylim")` give you positions of the plotting region and you can customize plot regions by `circos.rect`.

3.6 Update plotting region

If `track.index` is specified in `circos.trackPlotRegion` and the specified track is already created, the track will be updated with new graphics. In this case, settings related to the positions of the track such as the height of the track can not be modified.

```
circos.trackPlotRegion(data, ylim = c(0, 1), track.index = 1, ...)
```

For single cell, `circos.updatePlotRegion` can be used to erase all graphics that have been already plotted in the cell. In this case, you cannot re-define y-ranges in the cell either.

```
circos.updatePlotRegion(sector.index, track.index)
circos.points(x, y, sector.index, track.index)
```

3.7 Points

Adding points by `circos.points` is similar as `points` function. Possible usage is:

```
circos.points(x, y)
circos.points(x, y, sector.index, track.index)
circos.points(x, y, pch, col, cex)
```

Since `circos.points` is a low-level function, it can only be applied to cells which have been already created. If `sector.index` or `track.index` is not specified, it uses 'current' index for sector and track which are defined by the most recent `circos.trackPlotRegion` or `circos.updatePlotRegion`.

`circos.trackPoints` can add points in the whole cells on a same track as a batch. It is the same as if you use `circos.points` in a for loop.

3.8 Lines

Parameters for adding lines by `circos.lines` are similar to `lines` function, as illustrated in figure 9. One additional feature is that the areas under/above lines can be specified by `area` argument which

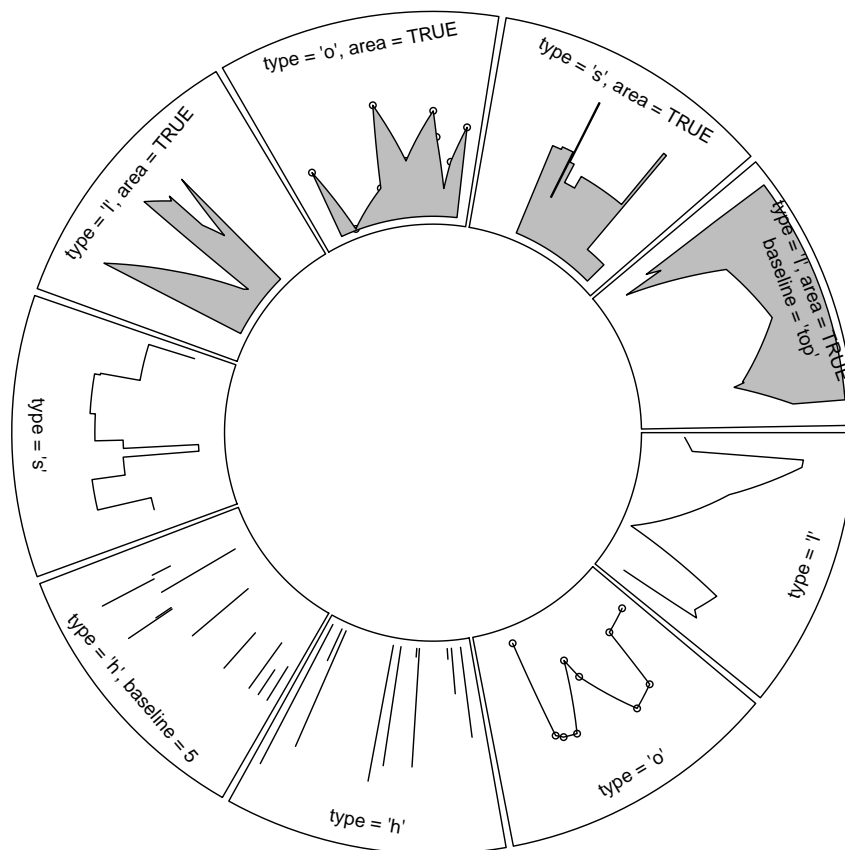

Figure 9: Line styles

can help to identify the direction of y-axes. Also the base line for the area can be set by `baseline`. `baseline` can be pre-defined string of `bottom` or `top`, or numeric values. `baseline` is also workable when `lty` is set to `h`.

Straight lines are transformed to curves when mapping to circular layout (figure 10). Normally, curves can be approximated by a series of segments of straight lines. With more segments, there would be better approximation, but with larger size if you generate figures into PDF files, especially for huge genomic data. Default number of segments in `circize` is a balance between the quality and size of the figure. Still you can change the number of segments by `circos.par("unit.circle.segments")`. The length of minimal segment is the length of the unit circle (2π) divided by `circos.par("unit.circle.segments")`. When you plot radical line, you can set `straight` argument to `TRUE` to get rid of unnecessary segmentation.

Possible usage for `circos.lines` is:

```
circos.lines(x, y)
circos.lines(x, y, sector.index, track.index)
circos.lines(x, y, col, lwd, lty, type, straight)
circos.lines(x, y, col, area, baseline, border)
```

Similar as `circos.points`, if no `sector.index` or `track.index` is specified, 'current' index would be used. Also, there is a `circos.trackLines` which is identical to `circos.lines` in a for loop.

3.9 Text

Only the facing of text by `circos.text` should be noted, as illustrated in figure 11. `srt` in text has been degenerated as `facing` in `circos.text` which support eight types of rotation that are pre-defined

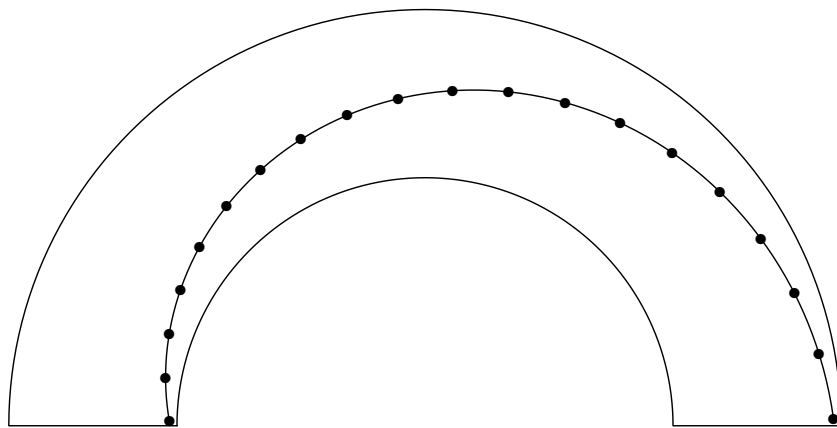
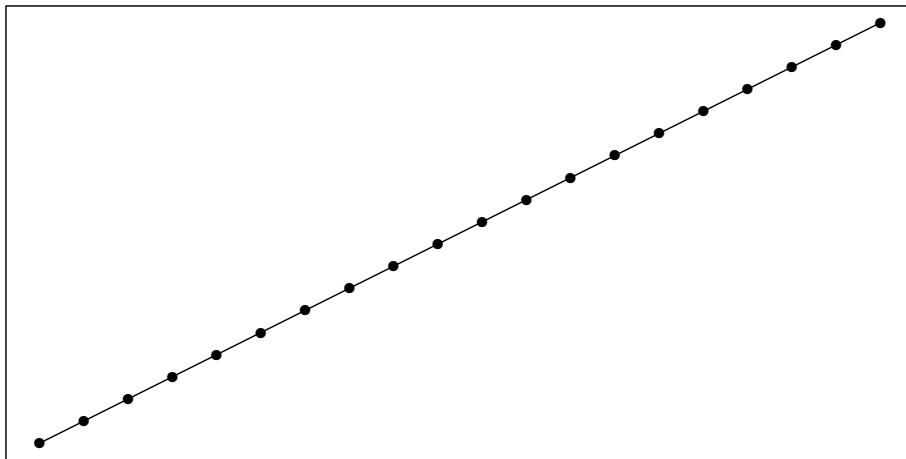

Figure 10: Straight lines will be transformed into curves in the circle.

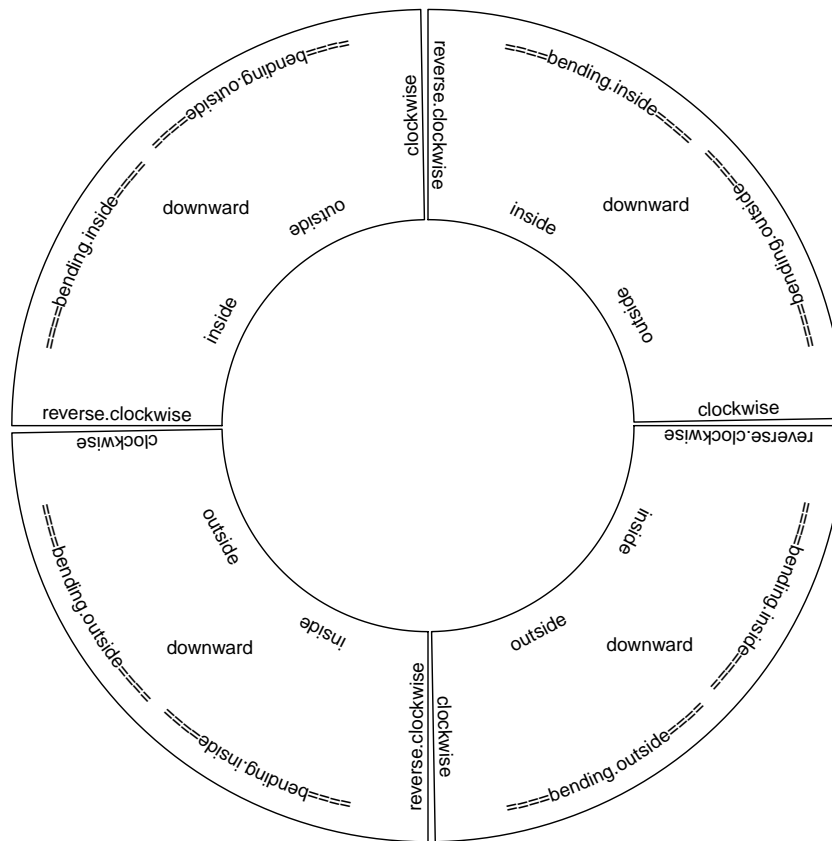

Figure 11: Text facing.

in (inside, outside, reverse.clockwise, clockwise, downward, bending.inside, bending.outside). But adj argument is still applicable in `circos.text`. Please note for `bending.inside` and `bending.outside`, currently, single line text is only supported. Possible usage for `circos.text` is:

```
circos.text(x, y, labels)
circos.text(x, y, labels, sector.index, track.index)
circos.text(x, y, labels, facing, adj, cex, col, font)
```

In some case, we may want to set the text facing more human-easy. For example, we want the text facing clockwise in right half of the circle while reverse-clockwise in the left half of the circle. This can be easily done by setting `niceFacing` to `TRUE`. This option only works for facing value of `inside`, `outside`, `clockwise`, `reverse.clockwise`, `bending.inside` and `bending.outside`. When `niceFacing` is on, values for internal facing and `adj` will be re-defined according to the position of the texts in the circle. Please refer to figure 12 for examples.

By default, `adj` adjusts text positions either horizontally or vertically. The adjustment can also be set as a degree that the text rotates by wrapping by degree function, then the other value in `adj` corresponds to the adjustment in radical direction. Which one in `adj` should be set as the degree value depends on the facing setting.

```
circos.text(x, y, labels, adj = c(0, degree(5)), facing = "clockwise")
```

There is also a `circos.trackText` in the package.

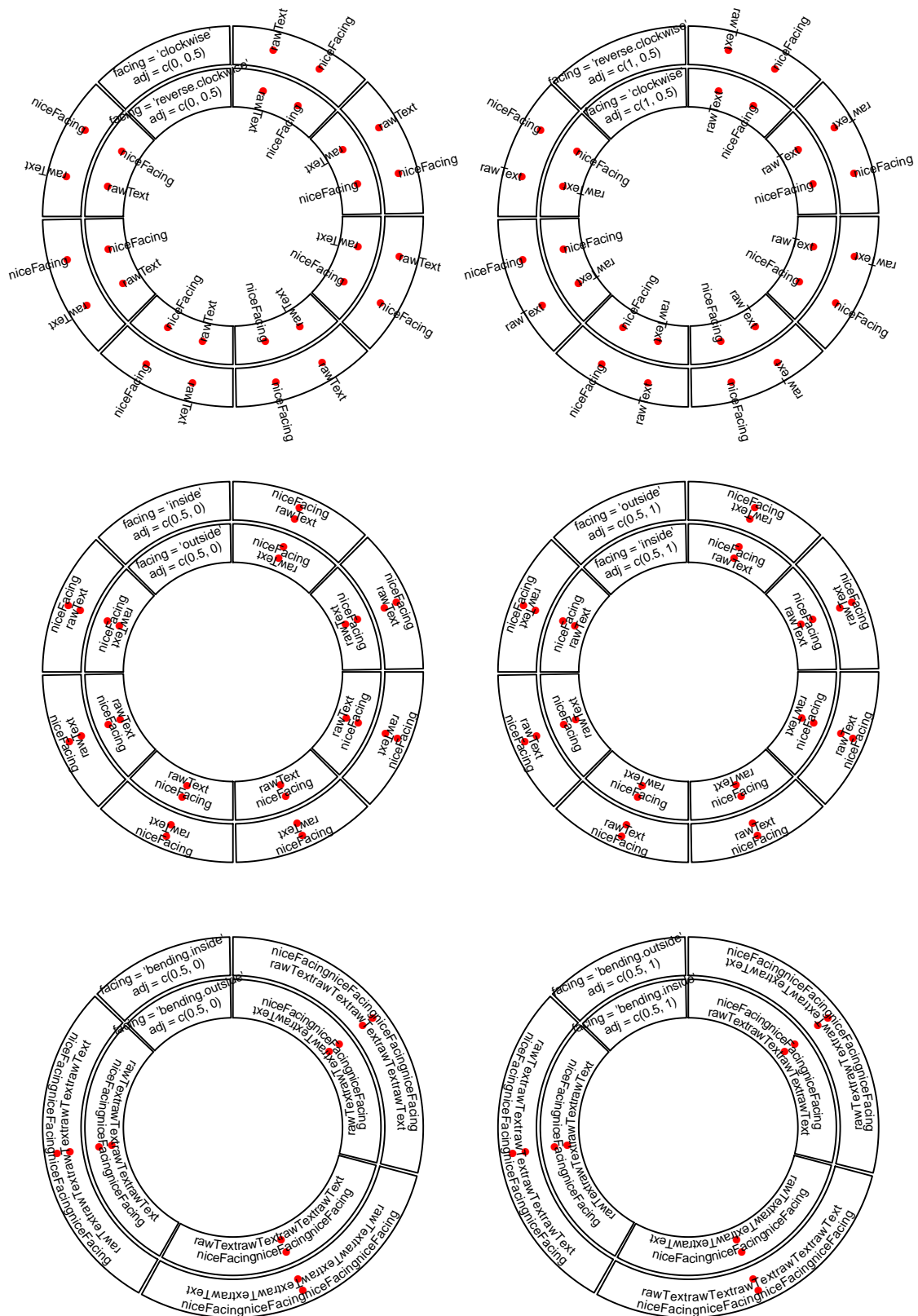

Figure 12: Human easy text facing. When `niceFacing` is on, settings in the same row are actually identical. Red dots represent positions of the texts.

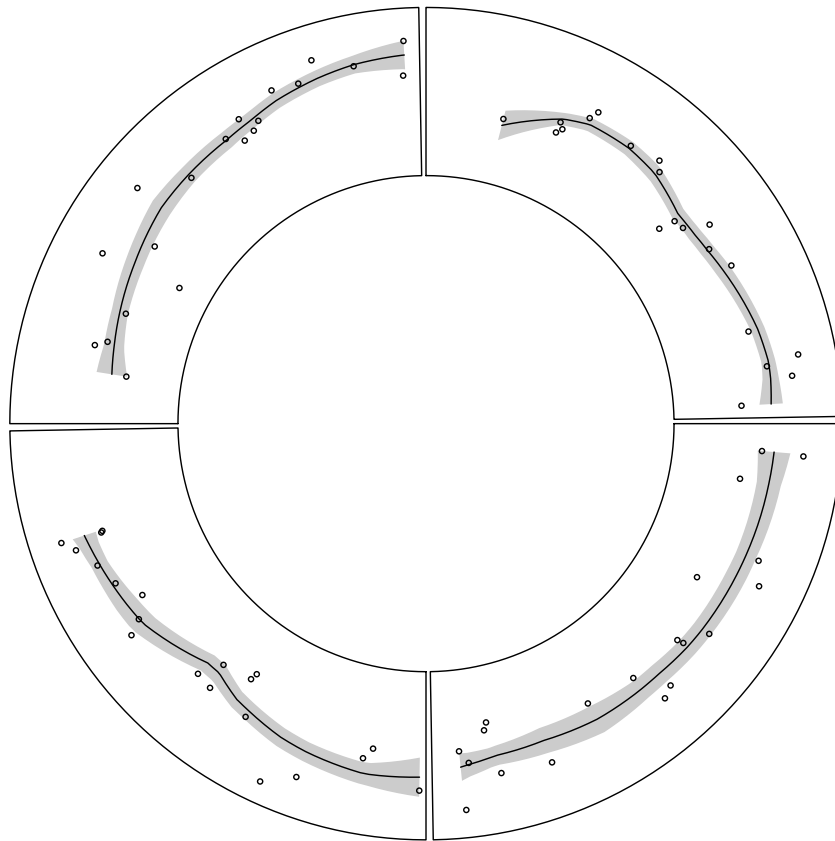

Figure 13: Area of standard deviation of the smoothed line.

3.10 Rectangle

If you imagine the plotting region in a cell as Cartesian coordinate, then `circos.rect` draws rectangles. In the circle, the up and bottom edge become two arcs. This function can be vectorized.

```
circos.rect(xleft, ybottom, xright, ytop)
circos.rect(xleft, ybottom, xright, ytop, sector.index, track.index)
circos.rect(xleft, ybottom, xright, ytop, col, border, lty, lwd)
```

3.11 Polygon

Similar as `circos.rect` and `polygon`, `circos.polygon` draws a polygon through a series of points in a cell:

```
circos.polygon(x, y)
circos.polygon(x, y, sector.index, track.index)
circos.polygon(x, y, col, border, lty, lwd)
```

In figure 13, the area of standard deviation of the smoothed line is drawn by `circos.polygon`. (Source code is in *Examples* section of `circos.polygon` help page.)

3.12 Axis

Because there may be no space to put y-axis, only adding x-axis for each cell is supported by `circos.axis`, as illustrated in figure 14. A lot of styles for axis can be set such as the position and length of major

ticks, the number of minor ticks, the position and direction of the axis labels and the position of the x-axis.

In figure 14, axis styles in different sectors are :

- a: Major ticks are calculated automatically, other settings are default.
- b: Ticks are pointing to inside of the circle, facing of tick labels is set to `outside`.
- c: Position of x-axis is bottom of the cell.
- d: Ticks are pointing to inside of the circle, facing of tick labels is set to `reverse.clockwise`.
- e: Self-defined major ticks.
- f: Self-defined major ticks and tick labels, no minor ticks.
- g: No ticks for both major and minor ones, facing of tick labels is set to `reverse.clockwise`.
- h: Number of minor ticks between two major ticks is set to 2. Length of ticks is longer and axis labels are more away from ticks. Facing of tick labels is set to `clockwise`.

The facing of labels text can also be optimized by `labels.niceFacing` (by default it is `TRUE`).

For `circos.axis`, possible usage is as follows. `h` can be pre-defined string of `bottom` or `top`, or numeric values.

```
circos.axis(h)
circos.axis(h, sector.index, track.index)
circos.axis(h, major.at, labels, major.tick)
circos.axis(h, major.at, labels, major.tick, labels.font, labels.cex,
            labels.facing, labels.away.percentage)
circos.axis(h, major.at, labels, major.tick, minor.ticks,
            major.tick.percentage, lwd)
```

Y-axis is also supported (figure 14), but you need to set `gap.degree` in `circos.par` to make sure there are enough spaces for y-axes.

```
circos.yaxis(side)
circos.yaxis(at, labels, sector.index, track.index)
```

3.13 Links

`circos.link` draws links from points and intervals (figure 15 A). If both ends are single points, the link is represented as a line. If one of the ends is an interval, the link would be a belt/ribbon. Links do not hold any position as tracks, so they can be overlapping with tracks.

Possible usage for `circos.link` is:

```
circos.link(sector.index1, 0, sector.index2, 0)
circos.link(sector.index1, c(0, 1), sector.index2, 0)
circos.link(sector.index1, c(0, 1), sector.index2, c(1, 2))
circos.link(sector.index1, c(0, 1), sector.index2, 0, col, lwd, lty, border)
```

The position of link 'root' is controlled by `rou`. By default, it is the end position of the most recently created track. So normally, you don't need to care about this setting. The default value of `rou` is calculated by an interval function `get_most_inside_radius()`:

```
circlize:::get_most_inside_radius
```

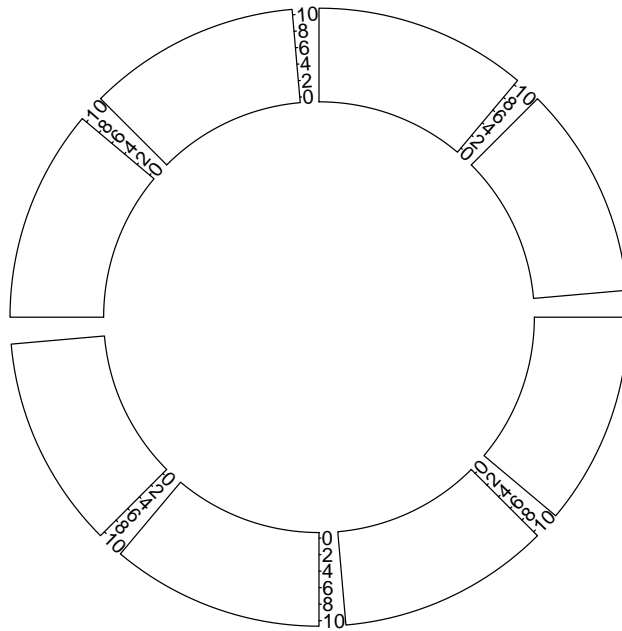
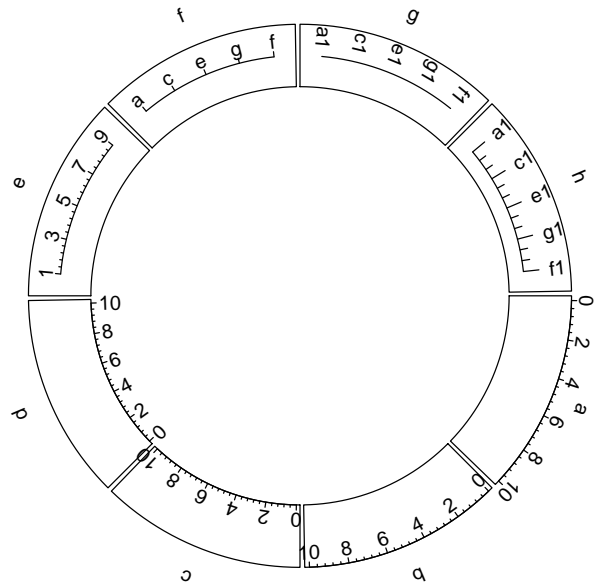

Figure 14: Axes

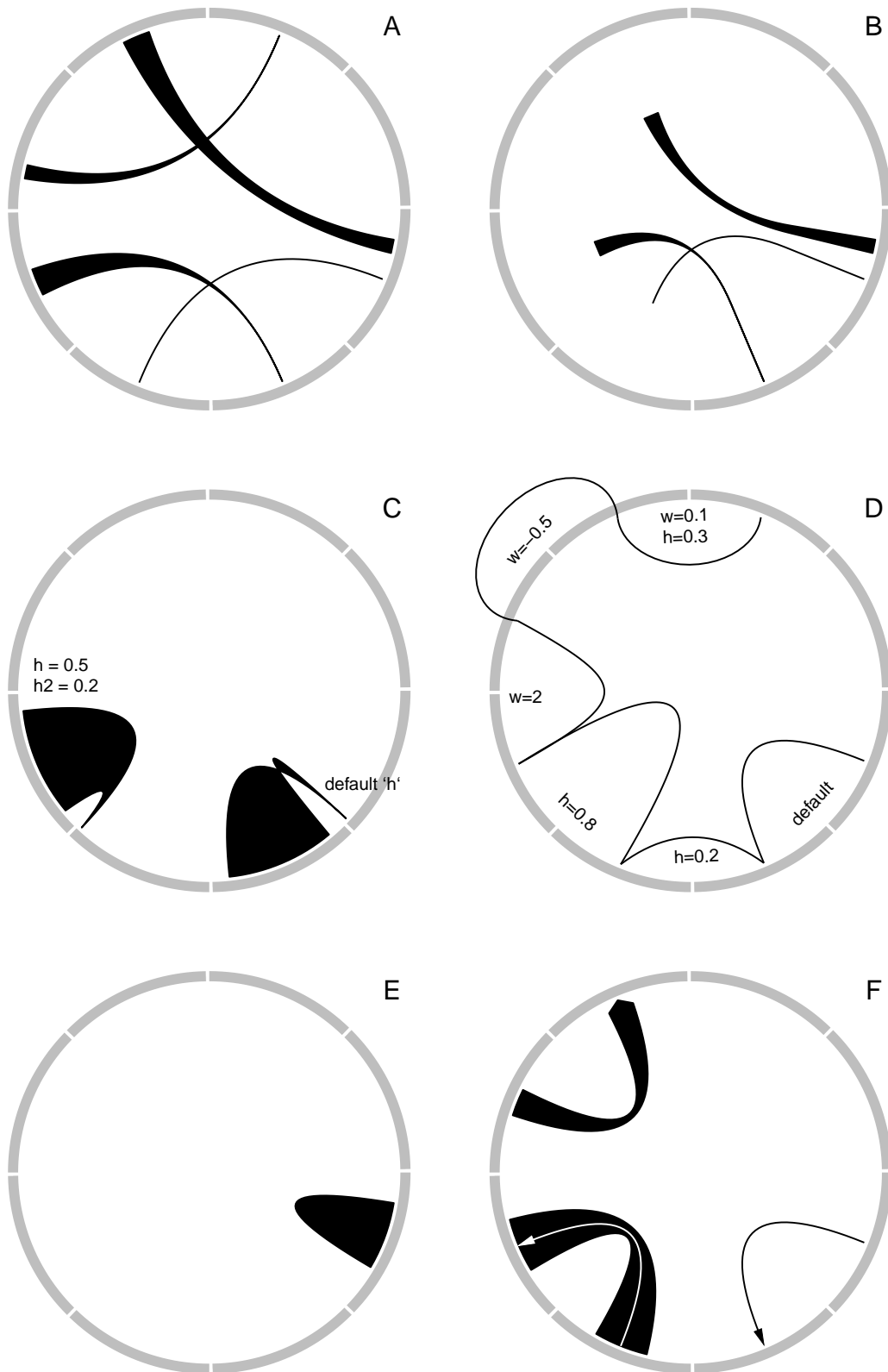

Figure 15: A) set different positions of roots; B) set different height of two borders. C,D) set different h and w . E) if two branches overlap, the link will be degenerated as a 'hill'. F) links with directions.

```
## function ()
## {
##   tracks = get.all.track.index()
##   if (length(tracks) == 0) {
##     1
##   }
##   else {
##     n = length(tracks)
##     get.cell.meta.data("cell.bottom.radius", track.index = tracks[n]) -
##       get.cell.meta.data("track.margin", track.index = tracks[n])[1] -
##       circos.par("track.margin")[2]
##   }
## }
## <environment: namespace:circlize>
```

By default, the two roots of the link are located in a same circle. The positions of two roots can be assigned with different values by `rou1` and `rou2` (figure 15 B).

```
circos.link(sector.index1, 0, sector.index2, 0, rou)
circos.link(sector.index1, 0, sector.index2, 0, rou1, rou2)
```

The height of the link can be controlled by `h` argument in `circos.link`.

When the link represents as a ribbon (i.e. link from point to interval or from interval to interval), It can not ensure that one border is always below or above the other. Which means, in some case, the two borders are intersected and the link would be messed up. It happens especially when position of the two ends are too close or the width of one end is extremely large while the width of the other end is too small. In that case, users can manually set height of the top and bottom border by `h` and `h2` (figure 15 C).

```
circos.link(sector.index1, 0, sector.index2, 0, h)
circos.link(sector.index1, 0, sector.index2, 0, h, h2)
```

The border of link is in fact a quadratic Bezier curve, so you can control the shape of the link by `w` and `w2` (`w2` controls the shape of bottom border, figure 15 D). For more explanation of `w`, please refer to http://en.wikipedia.org/wiki/B%C3%A9zier_curve#Rational_B.C3.A9zier_curves.

```
circos.link(sector.index1, 0, sector.index2, 0, w)
circos.link(sector.index1, 0, sector.index2, 0, w, w2)
```

If two branches overlap, the link will be de-generated as a 'hill' (figure 15, E). Also, links can have arrows to identify the directions (figure 15, F). For adding arrows, the `directional` argument with value 0 means there is no direction, 1 means the direction is from point1 to point2 and -1 means the direction is from point2 to point1. If the link represents as a belt, a line with arrow will be added in the center of the link to represent directions.

```
circos.link(sector.index1, 0, sector.index2, 0, directional = 1)
circos.link(sector.index1, c(0, 1), sector.index2, c(0, 1), directional = -1)
```

3.14 The `panel.fun` argument in `circos.trackPlotRegion`

`panel.fun` argument in `circos.trackPlotRegion` is useful to apply plotting as soon as the cell has been created. This self-defined function needs two arguments `x` and `y` which are data points that belong to this cell. The value for such values are automatically extracted from `x` and `y` in `circos.trackPlotRegion` according to the category argument factors. In the following example, inside `panel.fun`, for category `a`, `x` would be 1:3 and `y` are 5:3. If `x` or `y` in `circos.trackPlotRegion` is `NULL`, then `x` or `y` inside `panel.fun` is also `NULL`.

```

factors = c("a", "a", "a", "b", "b")
x = 1:5
y = 5:1
circos.trackPlotRegion(factors = factors, x = x, y = y,
  panel.fun = function(x, y) {
    circos.points(x, y)
  })

```

In `panel.fun`, one thing important is that if you use any low-level graphic functions, you don't need to specify `sector.index` and `track.index` explicitly. Remember that when applying `circos.trackPlotRegion`, cells in the track are created one after one. When a cell is created, `circos.trackPlotRegion` would set the sector index and track index of the cell as the 'current' index for the sector and track. When the cell is created, `panel.fun` would be executed immediately. Without specifying `sector.index` and `track.index`, the 'current' one would be used and that's exactly what you need.

The advantage of `panel.fun` is that it makes you feel you are using graphical functions in traditional graphic engine (You can see it is the same of using `circos.points(x, y)` and `points(x, y)`). It will be much easier for users to understand and customize new graphics.

Inside `panel.fun`, more information of the 'current' cell can be obtained through `get.cell.meta.data`. Also this function takes the 'current' sector and 'current' track by default, Explanation of `get.cell.meta.data` can be found in following section.

3.15 High-level plotting functions

With those low-level graphic functions such as `circos.points`, `circos.lines`, more high-level functions can be easily implemented. `circos.trackPlotRegion` provides a high-level function `circos.trackHist` which draws histograms or the density distributions of data (figure 16). Users can learn how to implement high-level functions to support graphs such as barplot, heatmap, ... according to the source code of `circos.trackHist`. In `circos.trackHist`, it first calls `hist` or `density` to calculate the distribution, then creates a new track, finally uses `circos.rect` or `circos.lines` to draw histograms or density distributions.

In figure 16, the first track is histograms in which all the `ylim` are the same. The second track is histograms in which `force.ylim` is `FALSE`. The third and the fourth tracks are density distributions in which y-lims are forced same or not.

In figure 17 there are heatmap and cluster dendrograms in circular layout. Heatmap is series of grids which can be drawn by `circos.rect`. Dendrograms are series of lines which can be drawn by `circos.lines`. Here we also have a high-level `circos.dendrogram` function to draw the dendrograms.

3.16 Other functions

`get.cell.meta.data` can provide detailed information for a cell. It needs the index of sector and track as arguments. As usual, it uses 'current' index by default.

```

get.cell.meta.data(name)
get.cell.meta.data(name, sector.index, track.index)

```

Items that can be extracted by `get.cell.meta.data` are:

- `sector.index`: The name (label) for the sector.
- `sector.numeric.index`: Numeric index for the sector. It is the numeric order of factors levels in initialization step.
- `track.index`: Numeric index for the track.
- `xlim`: Minimal and maximal values on the x-axis.
- `ylim`: Minimal and maximal values on the y-axis.
- `xcenter`: mean of `xlim`.

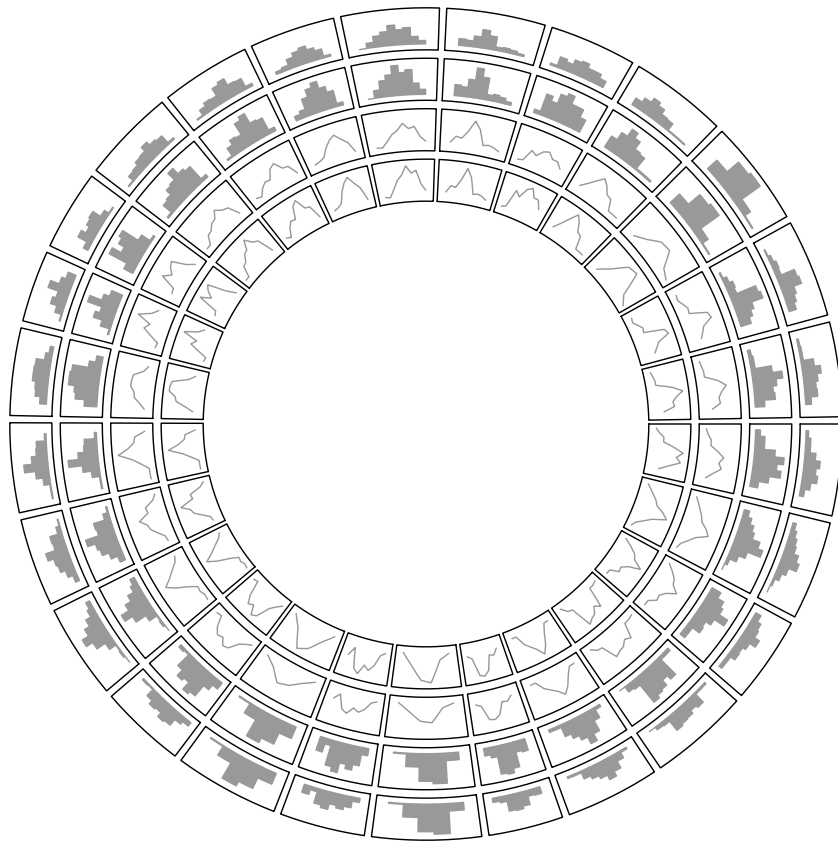

Figure 16: Histograms in circular layout.

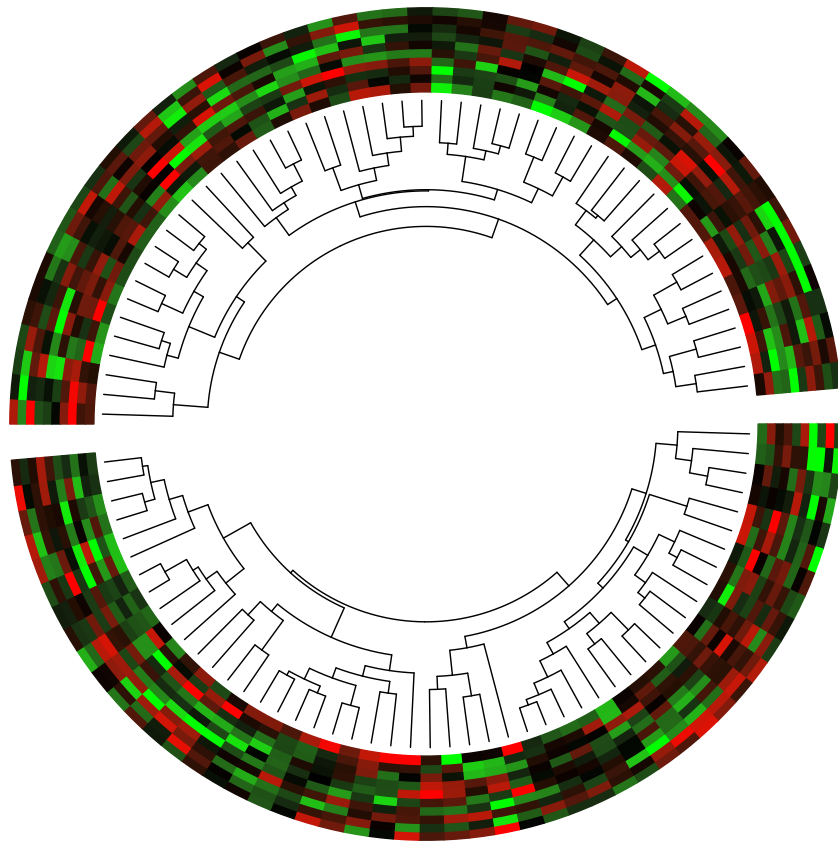

Figure 17: Circular heatmap with dendrogram trees.

- `ycenter`: mean of `ylim`.
- `xrange`: Range of `xlim`.
- `yrange`: Range of `ylim`.
- `cell.xlim`: Minimal and maximal values on the x-axis extended by cell paddings.
- `cell.ylim`: Minimal and maximal values on the y-axis extended by cell paddings.
- `xplot`: Degree of right and left borders in the plotting region. The first element corresponds to the start point of values on x-axis (`cell.xlim[1]`) and the second element corresponds to the end point of values on x-axis (`cell.xlim[2]`) Since x-axis in data coordinate in cells are always clockwise, `xplot[1]` is larger than `xplot[2]`.
- `yplot`: Radius of bottom and top radius in the plotting region.
- `cell.start.degree`: Same as `xplot[1]`.
- `cell.end.degree`: Same as `xplot[2]`.
- `cell.bottom.radius`: Same as `yplot[1]`.
- `cell.top.radius`: Same as `yplot[2]`.
- `track.margin`: Margins of the cell.
- `cell.padding`: Paddings of the cell.

One common use of `get.cell.meta.data` is to put inside `panel.fun` when calling `circos.trackPlotRegion`, then you can get detailed information for the 'current' cell where you want to put graphics.

The core function `circlize` transform from data coordinate (coordinate in the cells) to the polar coordinate and `reverse.circlize` transform from polar coordinate to data coordinate of a certain cell. The default transformation is applied in the 'current' cell.

```
factors = c("a", "b")
circos.initialize(factors, xlim = c(0, 1))
circos.trackPlotRegion(ylim = c(0, 1))
circlize(0.5, 0.5, sector.index = "a", track.index = 1)

##      theta  rou
## [1,] 270.5 0.89

reverse.circlize(90, 0.9, sector.index = "a", track.index = 1)

##           x    y
## [1,] 1.519774 0.56

reverse.circlize(90, 0.9, sector.index = "b", track.index = 1)

##           x    y
## [1,] 0.5028249 0.56

circos.clear()
```

The results are different for two `reverse.circlize` calls because the reference cells are different.

`draw.sector` draws sectors, rings or their parts. This is useful if you want to highlight some part of your circos plot. As you can guess, this function needs arguments of the position of circle center, the start degree and the end degree for sectors, and radius for two edges (or one edge) which are up or bottom border of a cell. Actually, `draw.sector` is independent from the circos plot.

```
draw.sector(start.degree, end.degree, rou1)
draw.sector(start.degree, end.degree, rou1, rou2, center)
draw.sector(start.degree, end.degree, rou1, rou2, center, col, border, lwd, lty)
```

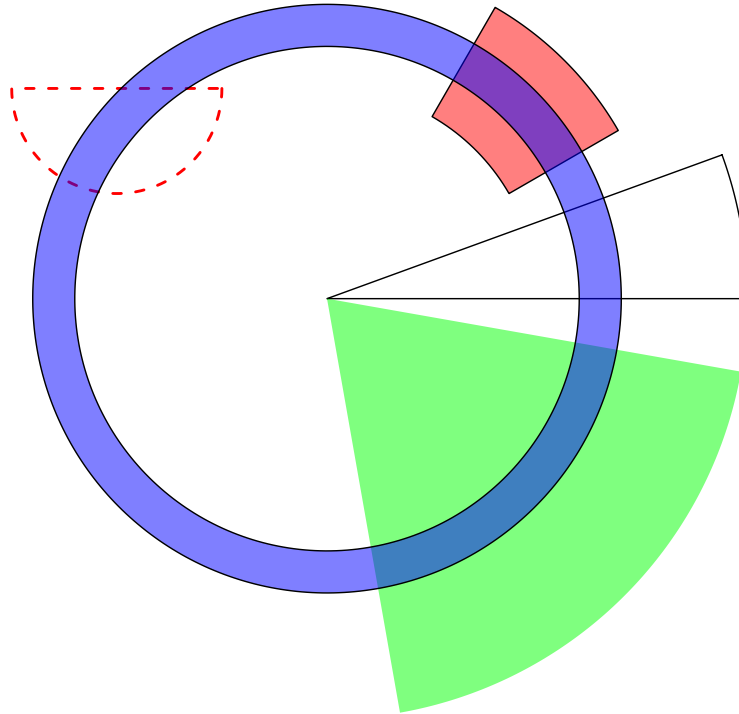

Figure 18: Examples of `draw.sector`.

Directions from `start.degree` and `end.degree` is important to draw sectors. By default, it is clock wise.

```
draw.sector(start.degree, end.degree, clock.wise = FALSE)
```

Following code shows some examples of `draw.sector` (figure 18).

```
par(mar = c(1, 1, 1, 1))
plot(c(-1, 1), c(-1, 1), type = "n", axes = FALSE, ann = FALSE)
draw.sector(20, 0)
draw.sector(30, 60, rou1 = 0.8, rou2 = 0.5, clock.wise = FALSE, col = "#FF000080")
draw.sector(350, 1000, col = "#00FF0080", border = NA)
draw.sector(0, 180, rou1 = 0.25, center = c(-0.5, 0.5), border = 2, lwd = 2, lty = 2)
draw.sector(0, 360, rou1 = 0.7, rou2 = 0.6, col = "#0000FF80")
```

In order to highlight cells in the circos plot, we can use `get.cell.meta.data` to get the information of positions of cells. E.g. the start degree and end degree can be obtained through `cell.start.degree` and `cell.end.degree`, and the position of the top border and bottom border on the circle radius can be obtained through `cell.top.radius` and `cell.bottom.radius`. Following code shows several examples to highlight sectors and tracks (figure 19 A).

```
par(mar = c(1, 1, 1, 1))
factors = letters[1:8]
circos.initialize(factors, xlim = c(0, 1))
```

```
for(i in 1:3) {
  circos.trackPlotRegion(ylim = c(0, 1))
}
circos.info(plot = TRUE)
```

If we want to highlight sector a:

```
draw.sector(get.cell.meta.data("cell.start.degree", sector.index = "a"),
            get.cell.meta.data("cell.end.degree", sector.index = "a"),
            rou1 = 1, col = "#FF000040")
```

If we want to highlight track 1:

```
draw.sector(0, 360,
            rou1 = get.cell.meta.data("cell.top.radius", track.index = 1),
            rou2 = get.cell.meta.data("cell.bottom.radius", track.index = 1),
            col = "#00FF0040")
```

If we want to highlight track 2 and 3 in sector e and f:

```
draw.sector(get.cell.meta.data("cell.start.degree", sector.index = "e"),
            get.cell.meta.data("cell.end.degree", sector.index = "f"),
            get.cell.meta.data("cell.top.radius", track.index = 2),
            get.cell.meta.data("cell.bottom.radius", track.index = 3),
            col = "#0000FF40")
```

If we want to highlight specific regions such as a small region inside cell (h:2), we can use `circlize` to calculate the exact positions on the circle. But always keep in mind that x-axis in the cell are always clock wise.

```
pos = circlize(c(0.2, 0.8), c(0.2, 0.8), sector.index = "h", track.index = 2)
draw.sector(pos[1, "theta"], pos[2, "theta"], pos[1, "rou"], pos[2, "rou"],
            clock.wise = TRUE, col = "#00FFFF40")
circos.clear()
```

If the purpose is simply highlight complete cells, there is a shortcut function `highlight.sector` for which you only need to specify index for sectors and tracks that you want to highlight (figure 19 B). It also supports to add text in the middle of a list of neighbouring sectors. Here `text.vjjust` can be used to adjust the position of the text in the radial direction.

```
factors = letters[1:8]
circos.initialize(factors, xlim = c(0, 1))
for(i in 1:4) {
  circos.trackPlotRegion(ylim = c(0, 1))
}
circos.info(plot = TRUE)

highlight.sector(c("a", "h"), track.index = 1, text = "a and h belong to a same group",
                facing = "bending.inside", niceFacing = TRUE, text.vjjust = -3)
highlight.sector("c", col = "#00FF0040")
highlight.sector("d", col = NA, border = "red", lwd = 2)
highlight.sector("e", col = "#0000FF40", track.index = c(2, 3))
highlight.sector(c("f", "g"), col = NA, border = "green",
                lwd = 2, track.index = c(2, 3))
highlight.sector(factors, col = "#FFFF0040", track.index = 4)
circos.clear()
```

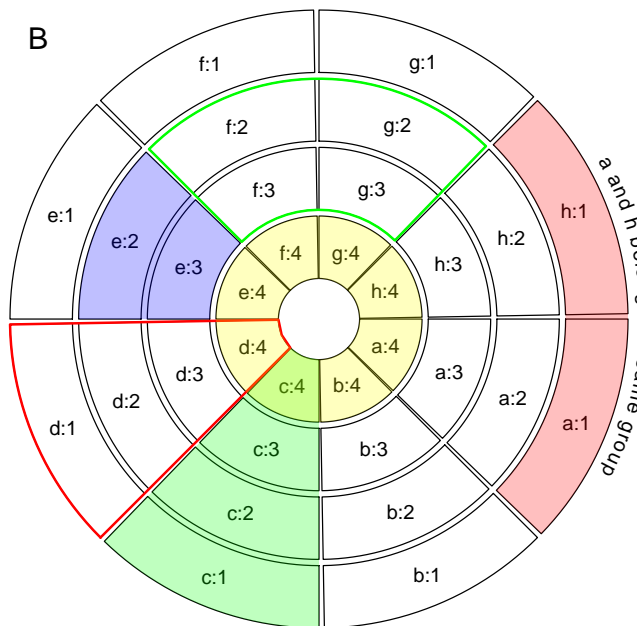
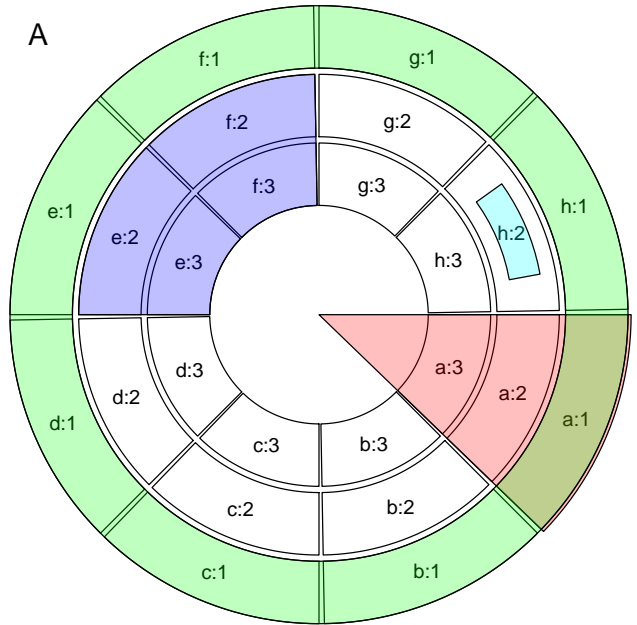

Figure 19: Highlight sectors and tracks. A) highlight by code draw.sector; B) highlight by highlight.sector.

3.17 Get information of circos plot

You can get basic information of your current circos plot by `circos.info`. The function can be applied at any time.

```
factors = letters[1:3]
circos.initialize(factors = factors, xlim = c(1, 2))
circos.info()

## All your sectors:
## [1] "a" "b" "c"
##
## No track has been created

circos.trackPlotRegion(ylim = c(0, 1))
circos.info(sector.index = "a", track.index = 1)

## sector index: 'a'
## track index: 1
## xlim: [1, 2]
## ylim: [0, 1]
## cell.xlim: [0.991453, 2.008547]
## cell.ylim: [-0.1, 1.1]
## xplot (degree): [360, 241]
## yplot (radius): [0.79, 0.99]
## track.margin: c(0.01, 0.01)
## cell.padding: c(0.02, 1, 0.02, 1)
##
## Your current sector.index is c
## Your current track.index is 1

circos.clear()
```

It can also add labels to cells by `circos.info(plot = TRUE)`.

3.18 Do not forget `circos.clear`

You should always call `circos.clear` to complete the circos plot. Because there are several parameters for circos plot which can only be set before `circos.initialize`. So before you draw the next circos plot, you need to reset all these parameters.

3.19 A simple example of implementing high-level graphics

We will show a simple example (figure 20) which combines several low-level graphic functions to construct complicated graphics for specific purpose.

In the following code, we make histogram in another circular way. The bars are added by `circos.rect`, reference lines are added by `circos.lines`, labels are added by `circos.text` and axes are added by `circos.axis`.

```
category = paste0("category", "_", 1:10)
percent = sort(sample(40:80, 10))
color = rev(rainbow(length(percent)))

par(mar = c(1, 1, 1, 1))
circos.par("start.degree" = 90)
circos.initialize("a", xlim = c(0, 100)) # 'a` just means there is one sector
circos.trackPlotRegion(ylim = c(0.5, length(percent)+0.5), , track.height = 0.8,
  bg.border = NA, panel.fun = function(x, y) {
    xlim = get.cell.meta.data("xlim") # in fact, it is c(0, 100)
```

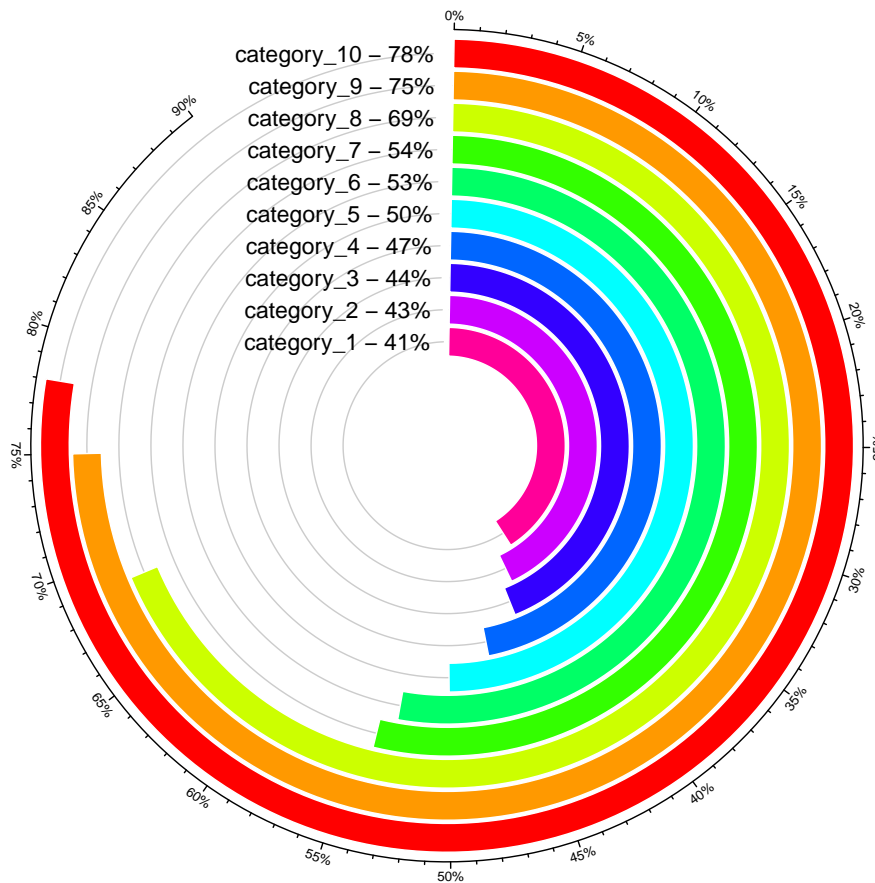

Figure 20: Combine low-level graphic functions to generate high-level graphics.

```

for(i in seq_along(percent)) {
  circos.lines(xlim, c(i, i), col = "#CCCCCC")
  circos.rect(0, i - 0.45, percent[i], i + 0.45, col = color[i],
             border = "white")
}

for(i in seq_along(percent)) {
  circos.text(xlim[1], i, paste0(category[i], " - ", percent[i], "%"),
             facing = "downward", adj = c(1.1, 0.5))
}

breaks = seq(0, 90, by = 5)
circos.axis(h = "top", major.at = breaks, labels = paste0(breaks, "%"),
           major.tick.percentage = 0.02, labels.cex = 0.6,
           labels.away.percentage = 0.01)
})

circos.clear()

```

4 Advanced technique

4.1 Zooming of sectors

Under the default settings, width of sectors are calculated according to the range of data in each category. In some circumstance, you may want to manually set the width of each sector. Normally it is not a good idea since width of sectors can reflect useful information of your data. However, sometimes it is useful to modify the width of sectors, e.g., you want to put your plot only in half of the circle while in the other half of the circle, zooming of certain sectors are applied. The width of sectors can be manually set by `sector.width` argument in `circos.initialize`. The value for the argument should be a vector with length of either one or as same as the number of categories (again, order of `sector.width` vector corresponds to the order of levels of factors). `sector.width` is relative value, and it will be scaled to percentage (e.g. if you set `sector.width` to `c(1, 3)`, it will be scaled as `c(0.25, 0.75)`).

In order to zoom e.g. one sector, the copy of the data corresponding to this sector should be attached to the original data. Since these two sectors (original sector and the zoomed sector) contain the same data, if same plotting functions are applied to them, there will be same graphics generated.

In the following code, sector a and b are zoomed. To make thing simple, we put all data into one data frame.

```
df = data.frame(factors = sample(letters[1:6], 100, replace = TRUE),
               x = rnorm(100),
               y = rnorm(100),
               stringsAsFactors = FALSE)
```

Extract the data for sector a and b, and assign to a new variable.

```
zoom_df = df[df$factors %in% c("a", "b"), ]
```

Modify the names for the zoomed sector, because in the circos plot, zoomed sectors are same as other normal sectors. Attach to the original data frame.

```
zoom_df$factors = paste0("zoom_", zoom_df$factors)
df2 = rbind(df, zoom_df)
```

In order to put the normal sectors in half of the circle and the zoomed sectors in the other half, just normalize the width of normal sectors and normalize the width of zoomed sectors separately.

```
xrange = tapply(df2$x, df2$factors, function(x) max(x) - min(x))
normal_sector_index = unique(df2$factors)
zoomed_sector_index = unique(zoom_df$factors)
sector.width = c(xrange[normal_sector_index] / sum(xrange[normal_sector_index]),
                 xrange[zoomed_sector_index] / sum(xrange[zoomed_sector_index]))
```

Now make the circos plot in the normal way.

```
par(mar = c(1, 1, 1, 1))
circos.par(start.degree = 90)
circos.initialize(df2$factors, x = df2$x, sector.width = sector.width)
circos.trackPlotRegion(df2$factors, x = df2$x, y = df2$y, panel.fun = function(x, y) {
  circos.points(x, y, col = "red", pch = 16, cex = 0.5)
  xlim = get.cell.meta.data("xlim")
  ylim = get.cell.meta.data("ylim")
  sector.index = get.cell.meta.data("sector.index")
  circos.text(mean(xlim), mean(ylim), sector.index, niceFacing = TRUE)
})
```

If you want to add links from original sectors to zoomed sectors,

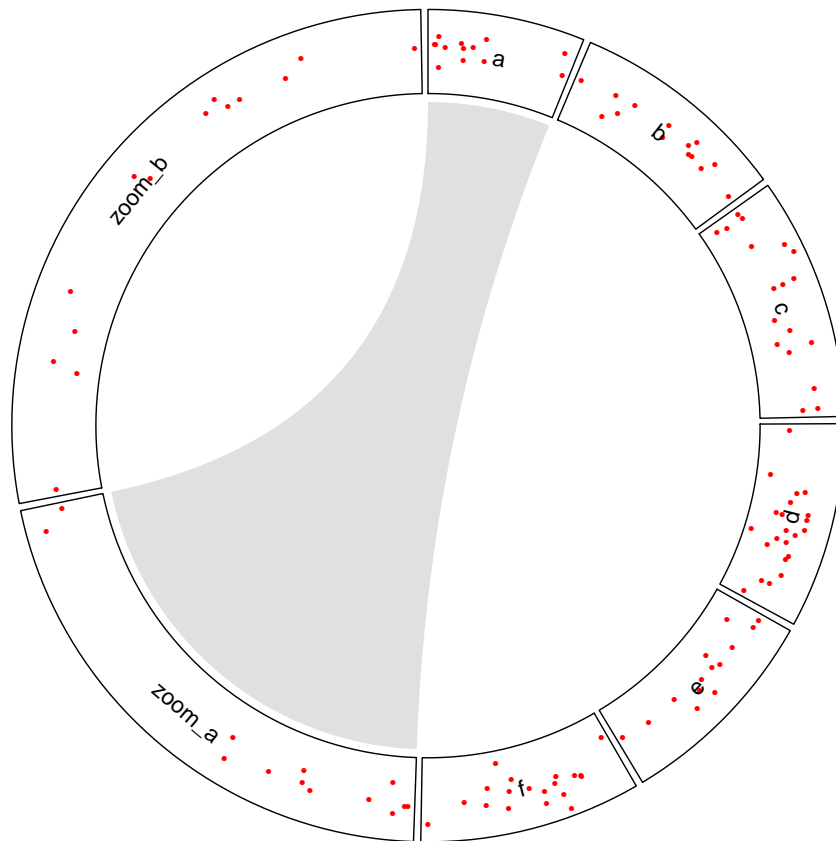

Figure 21: Zoom sectors.

```

circos.link("a", get.cell.meta.data("cell.xlim", sector.index = "a"),
           "zoom_a", get.cell.meta.data("cell.xlim", sector.index = "zoom_a"),
           border = NA, col = "#00000020")
circos.clear()

```

4.2 Draw part of the circos layout

`canvas.xlim` and `canvas.ylim` in `circos.par` is useful to make figures on only part of circle. In the example, only sectors between 0° to 90° are plotted (figure 22). First, four sectors with the same width are initialized. Then only the first sector is drawn with points and lines. From figure 22, we in fact created the whole circle, but only a quarter of the circle is in the canvas region. Codes are as follows.

```

par(mar = c(1, 1, 1, 1))
circos.par("canvas.xlim" = c(0, 1), "canvas.ylim" = c(0, 1),
          "clock.wise" = FALSE, "gap.degree" = 0)
factors = letters[1:4]
circos.initialize(factors = factors, xlim = c(0, 1))
circos.trackPlotRegion(factors = factors, ylim = c(0, 1), bg.border = NA)
circos.updatePlotRegion(sector.index = "a", bg.border = "black")
x1 = runif(100)
y1 = runif(100)
circos.points(x1, y1, pch = 16, cex = 0.5)
circos.trackPlotRegion(factors = factors, ylim = c(0, 1), bg.border = NA)

```

```

circos.updatePlotRegion(sector.index = "a", bg.border = "black")
circos.lines(1:100/100, y1, pch = 16, cex = 0.5)
circos.clear()

```

In the second situation, in some tracks, you only need to add graphic on subset of sectors. Remember when you are creating new track with `circos.trackPlotRegion` and set `bg.col` and `bg.border` to `NA`, it means create the new track while draw nothing. After that, you can use `circos.updatePlotRegion` to update these invisible cells of interest and add graphics on it (figure 23).

```

par(mar = c(1, 1, 1, 1))
factors = letters[1:4]
circos.initialize(factors = factors, xlim = c(0, 1))
circos.trackPlotRegion(factors = factors, ylim = c(0, 1), bg.col = NA, bg.border = NA)
circos.updatePlotRegion(sector.index = "a", bg.border = "black")
x1 = runif(100)
y1 = runif(100)
circos.points(x1, y1, pch = 16, cex = 0.5)

circos.trackPlotRegion(factors = factors, ylim = c(0, 1), bg.col = NA, bg.border = NA)
circos.updatePlotRegion(sector.index = "a", bg.border = "black")
x1 = runif(100)
y1 = runif(100)
circos.points(x1, y1, pch = 16, cex = 0.5)

circos.trackPlotRegion(factors = factors, ylim = c(0, 1))
circos.trackPlotRegion(factors = factors, ylim = c(0, 1))
circos.clear()

```

4.3 Combine more than one circos plots

Since circular layout by `circize` is finally plotted in an ordinary R plotting system. Two separated circular layouts can be plotted together by some tricks. Here the key is `par(new = TRUE)` which allows to draw a new figure on the previous canvas region. **Just remember the radius of the circos is always 1.**

The first example is to make one outer circos plot and an inner circos plot (figure 24).

```

par(mar = c(1, 1, 1, 1))
factors = letters[1:4]
circos.initialize(factors = factors, xlim = c(0, 1))
circos.trackPlotRegion(ylim = c(0, 1), panel.fun = function(x, y) {
  circos.text(0.5, 0.5, "outer circos")
})
circos.clear()

par(new = TRUE)
circos.par("canvas.xlim" = c(-2, 2), "canvas.ylim" = c(-2, 2))
factors = letters[1:3]
circos.initialize(factors = factors, xlim = c(0, 1))
circos.trackPlotRegion(ylim = c(0, 1), panel.fun = function(x, y) {
  circos.text(0.5, 0.5, "inner circos")
})
circos.clear()

```

The second example is to make two separated circos plot in which every circos plot only contains a half (figure 25).

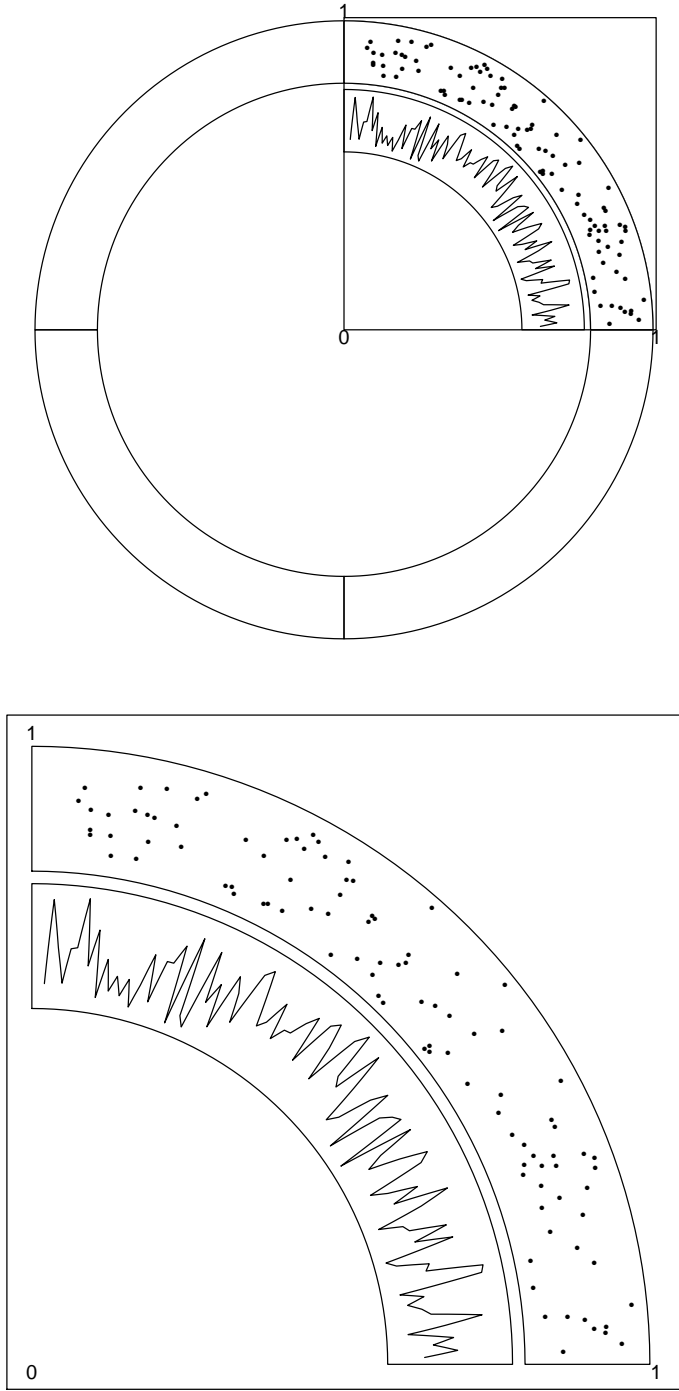

Figure 22: One quarter of the circle.

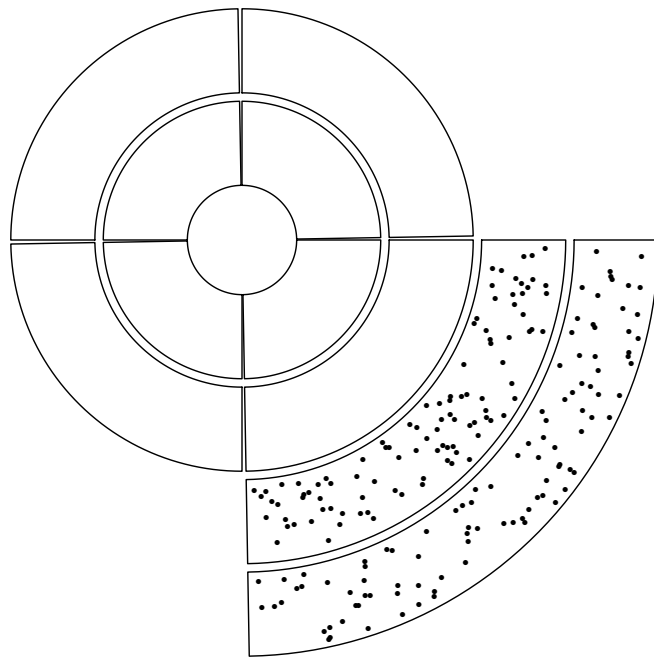

Figure 23: Only plot subset of sectors in certain tracks.

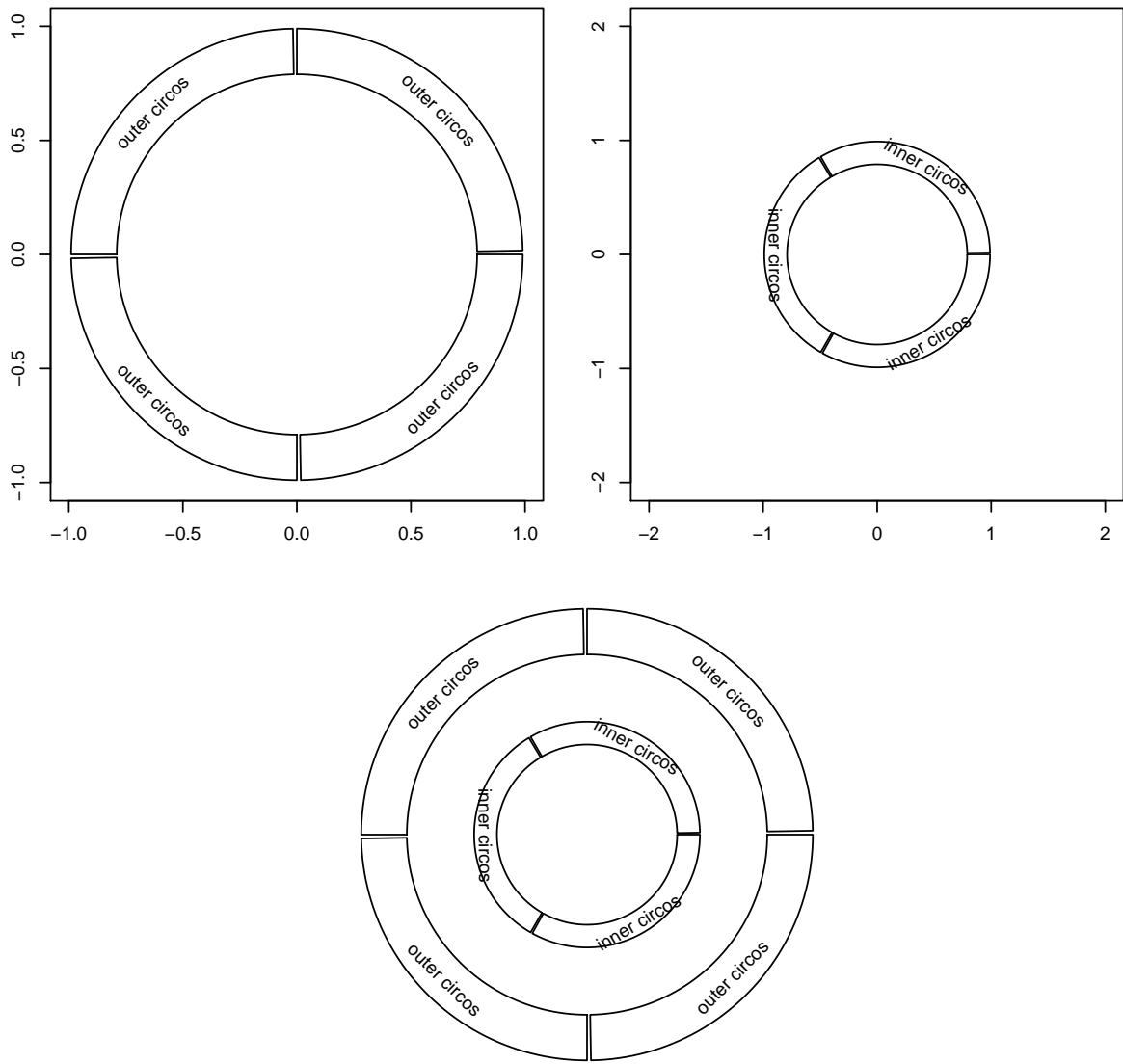

Figure 24: An outer circos plot plus an inner one.

```

par(mar = c(1, 1, 1, 1))
factors = letters[1:4]
circos.par("canvas.xlim" = c(-1, 1.5), "canvas.ylim" = c(-1, 1.5), start.degree = -45)
circos.initialize(factors = factors, xlim = c(0, 1))
circos.trackPlotRegion(ylim = c(0, 1), bg.col = NA, bg.border = NA)
circos.updatePlotRegion(sector.index = "a")
circos.text(0.5, 0.5, "first one")
circos.updatePlotRegion(sector.index = "b")
circos.text(0.5, 0.5, "first one")

circos.clear()

par(new = TRUE)
circos.par("canvas.xlim" = c(-1.5, 1), "canvas.ylim" = c(-1.5, 1), start.degree = -45)
circos.initialize(factors = factors, xlim = c(0, 1))
circos.trackPlotRegion(ylim = c(0, 1), bg.col = NA, bg.border = NA)
circos.updatePlotRegion(sector.index = "d")
circos.text(0.5, 0.5, "second one")
circos.updatePlotRegion(sector.index = "c")
circos.text(0.5, 0.5, "second one")

circos.clear()

```

The third example is to draw sectors with different radius (figure 26). In fact, it makes four `circos` plots in which only one sector of each graphs is plotted. Note links can not be drawn in these different sectors because links can only be drawn in one `circos` plot.

```

library(circlize)
par(mar = c(1, 1, 1, 1))
factors = letters[1:4]
lim = c(1, 1.1, 1.2, 1.3)
for(i in 1:4) {
  circos.par("canvas.xlim" = c(-lim[i], lim[i]),
            "canvas.ylim" = c(-lim[i], lim[i]), "track.height" = 0.4)
  circos.initialize(factors = factors, xlim = c(0, 1))
  circos.trackPlotRegion(ylim = c(0, 1), bg.border = NA)
  circos.updatePlotRegion(sector.index = factors[i], bg.border = "black")
  circos.points(runif(10), runif(10), pch = 16)
  circos.clear()
  par(new = TRUE)
}
par(new = FALSE)

```

It is different from example in “Draw part of the `circos` layout” section. In that example, cells both visible and invisible all belong to a same track and they are in a same `circos` plot, so they should have same radius. But here, cells have different radius and they belong to different `circos` plot.

4.4 Draw outside and combine with canvas coordinate

Sometimes it is very useful to draw something outside plotting region. (You can think it is similar as `par(xpd = NA)` setting.) The following is a simple example to illustrate such circumstance (figure 27).

```

set.seed(12345)
par(mar = c(1, 1, 1, 1))
factors = letters[1:4]
circos.par("canvas.xlim" = c(-1.5, 1.5), "canvas.ylim" = c(-1.5, 1.5), "gap.degree" = 10)
circos.initialize(factors = factors, xlim = c(0, 1))
circos.trackPlotRegion(ylim = c(0, 1), panel.fun = function(x, y) {

```

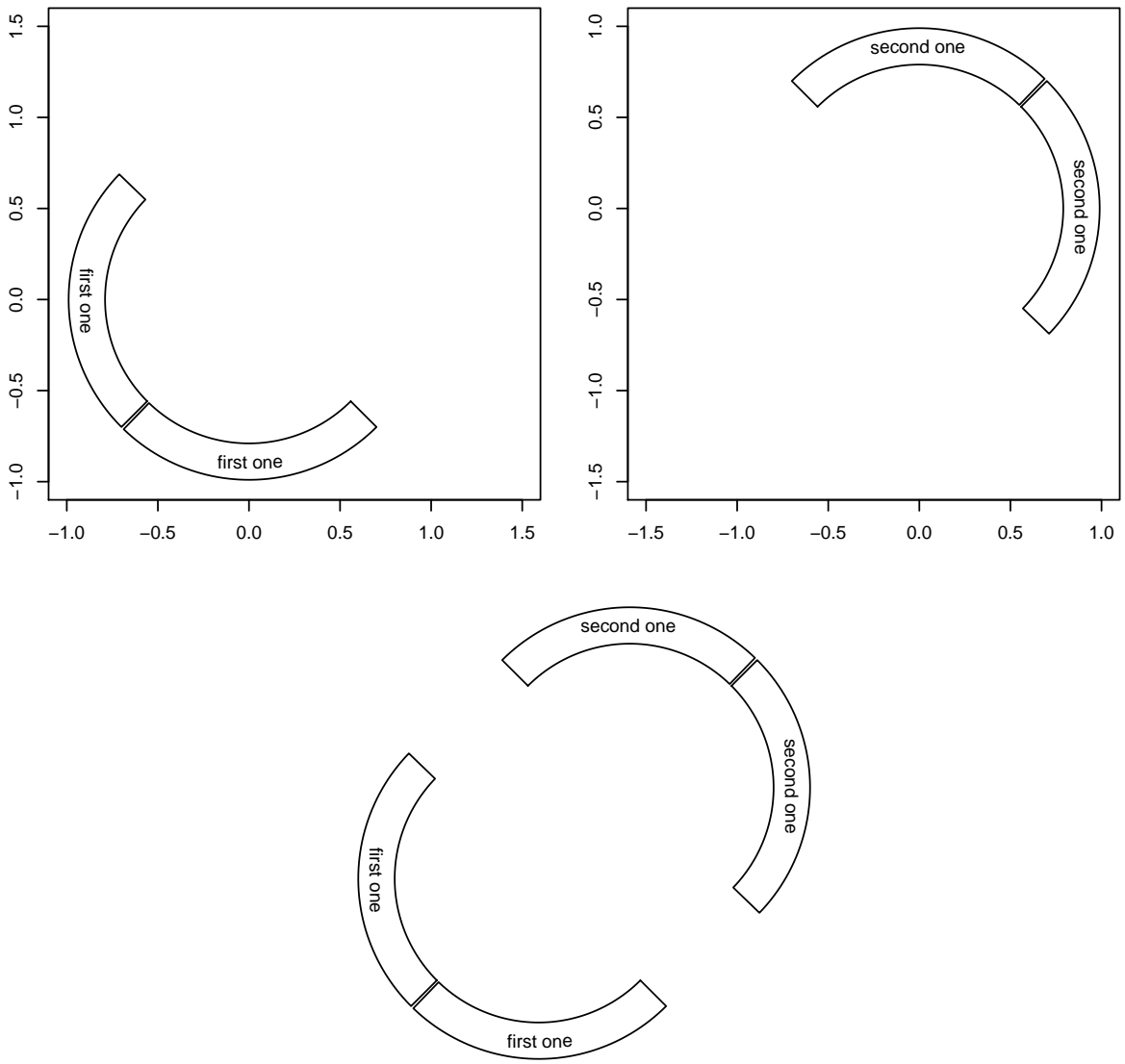

Figure 25: Two separated circles plots

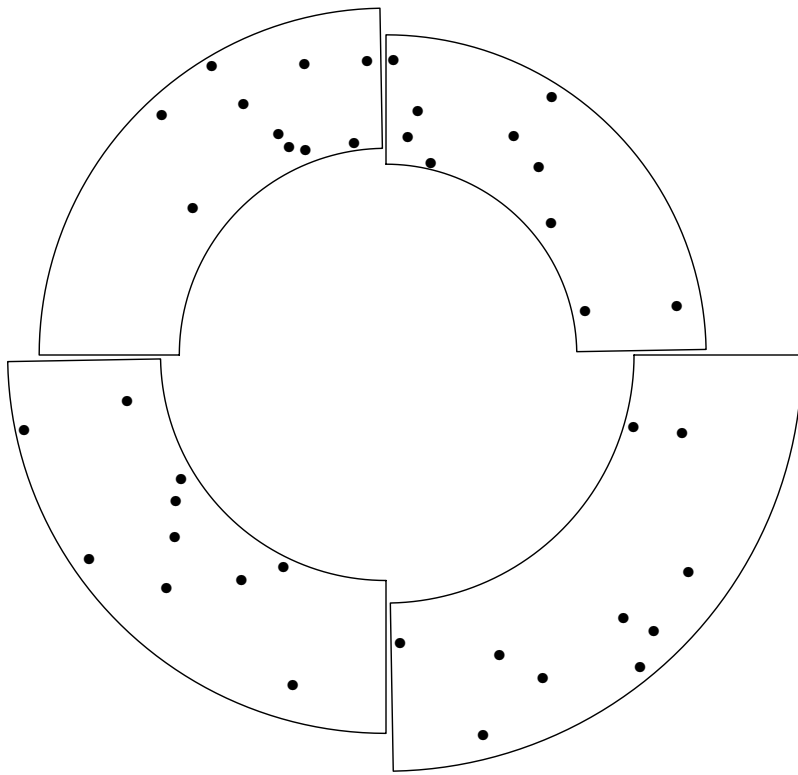

Figure 26: Sectors with different radius.

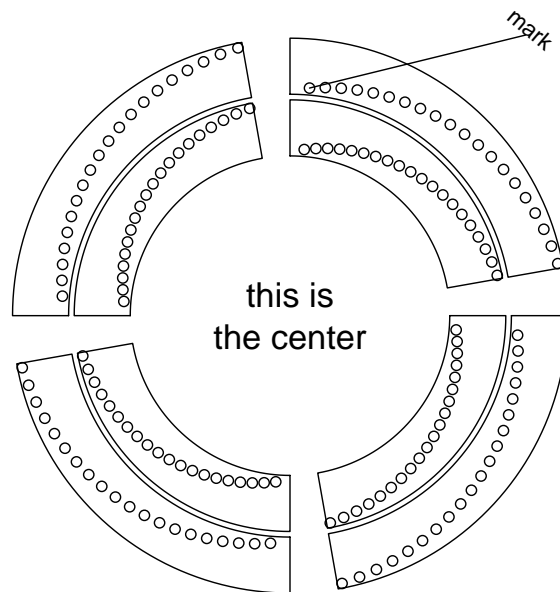

Figure 27: Draw outside the cell and combine with canvas coordinate.

```

    circos.points(1:20/20, 1:20/20)
  })
  circos.lines(c(1/20, 0.5), c(1/20, 3), sector.index = "d", straight = TRUE)
  circos.text(0.5, 3, "mark", sector.index = "d", adj = c(0.5, 0))

  circos.trackPlotRegion(ylim = c(0, 1), panel.fun = function(x, y) {
    circos.points(1:20/20, 1:20/20)
  })
  text(0, 0, "this is\nthe center", cex = 1.5)
  legend("bottomleft", pch = 1, legend = "this is the legend")
  circos.clear()

```

Since the final graphics are plotted in an ordinary canvas plotting region, we can add additional graphics through the traditional way, such as legends, texts, ...

4.5 Arrange figures with layouts

You can use layout to arrange multiple figures together (also it is available by `par(mfrow)` or `par(mfcol)`) (figure 28).

```

layout(matrix(1:9, 3, 3))
for(i in 1:9) {
  factors = 1:8
  par(mar = c(0.5, 0.5, 0.5, 0.5))

```

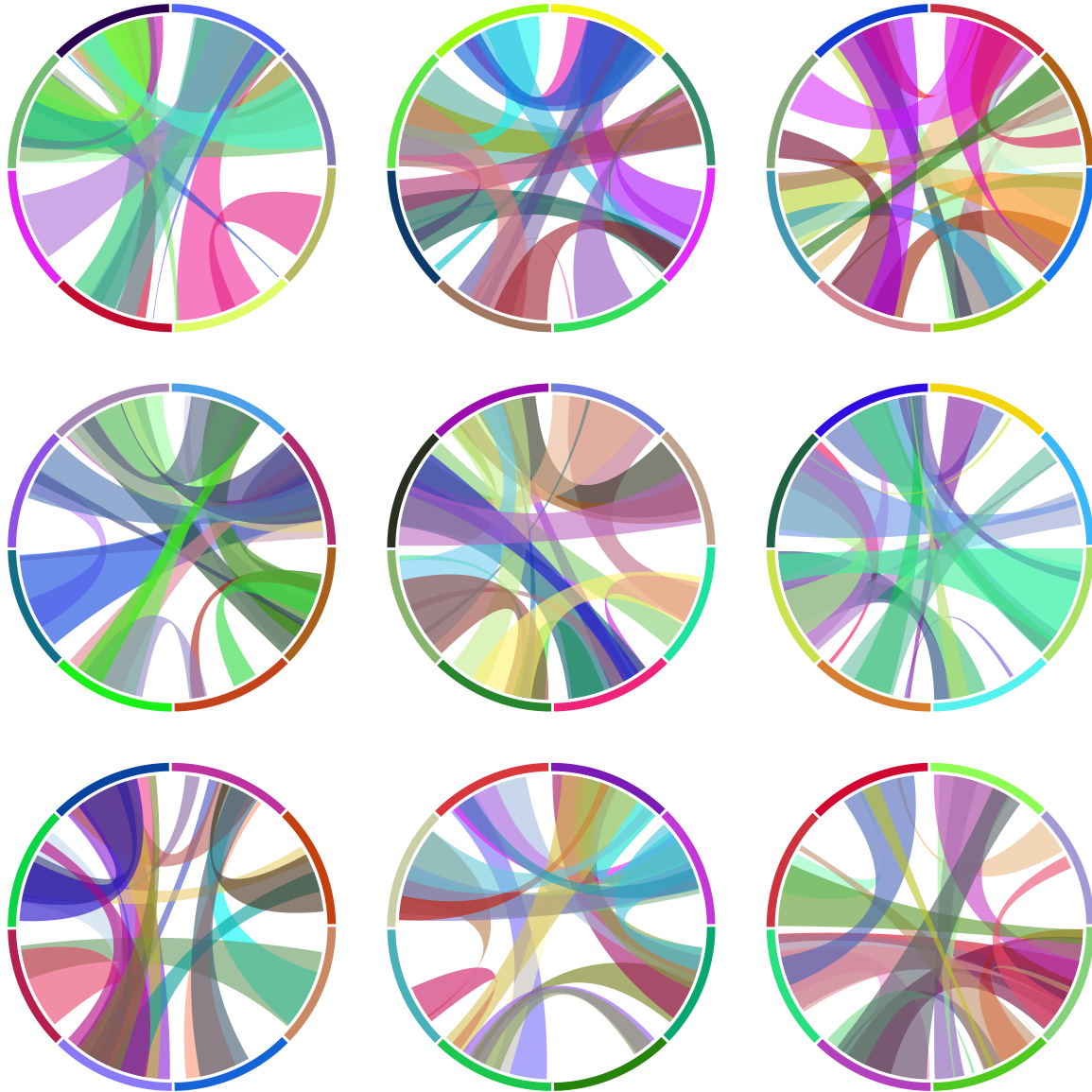

Figure 28: Arrange multiple circos plots.

```

circos.par(cell.padding = c(0, 0, 0, 0))
circos.initialize(factors, xlim = c(0, 1))
circos.trackPlotRegion(ylim = c(0, 1), track.height = 0.05,
  bg.col = rand_color(8), bg.border = NA)
for(i in 1:20) {
  se = sample(1:8, 2)
  circos.link(se[1], runif(2), se[2], runif(2),
    col = rand_color(1, transparency = 0.4), border = NA)
}
circos.clear()
}

```